

# Engineering Manual

BC/BP-Series Centrifugal Pump

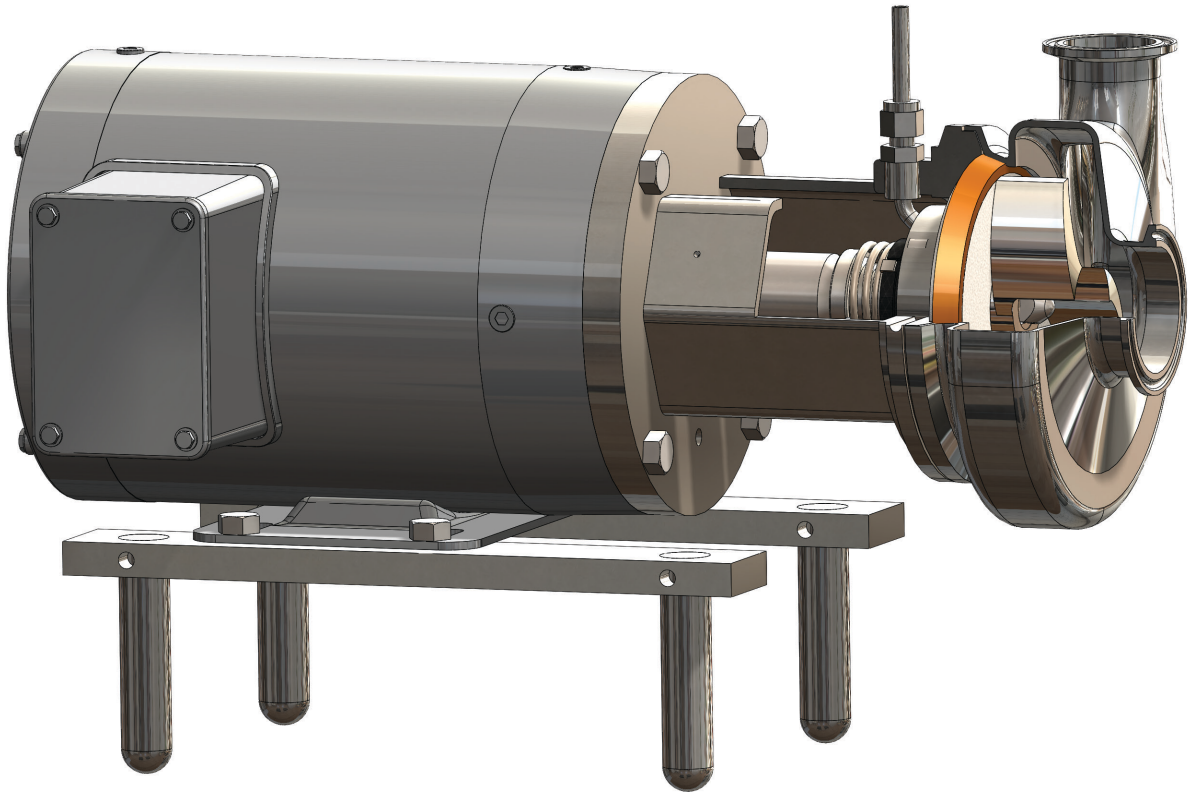

***Read and understand this manual prior to installing, operating or servicing this equipment***



*The Right Connection®*

***Updated June 2015***

# Table of Contents

Introduction.....	2	Dimensions.....	27-28
Mechanical Specifications.....	3	Troubleshooting.....	29-30
Family of Curves.....	3	Friction Loss Chart.....	31
Seal Options.....	3	CIP Flow Rate.....	32
D seal.....	3	Water Vapor Pressure Chart.....	32
F seal.....	3	Centrifugal Pump Characteristics.....	33
DG seal.....	3	Viscosity Chart.....	34-35
BC Vs. BP.....	4	Pump Model No.s.....	36
How to Read a Curve.....	5-6	Repair Kits.....	37-38
Curves.....	7-26	Part Number Descriptions.....	39
BC114.....	7-8	Casing Drain Options.....	40
BC214.....	9-10	Check List.....	41
BC216.....	11-12	Glossary.....	42-53
BC516.....	13-14	Warranty.....	54
BC218.....	15-16		
BC318.....	17-18		
BC328.....	19-20		
BC428.....	21-22		
BP441.....	23-24		
BP641.....	25-26		

---

## Introduction

The WARNING sign is contained in this manual to alert conditions which may cause serious injury and/or possible damage to equipment, pay attention to these messages.



Hazards or unsafe practices which could result in minor or moderate injury. May also be used to alert against an unsafe operating or maintenance practice.

---

The information contained in this manual is to help you in selecting the correct Dixon Sanitary BC/BP-Series Centrifugal pump for your application.

Please refer to the Instruction and Operations manual of the pump after selection and purchase of the pump, prior to installation.



# Mechanical Specifications

## Standard Construction

- Volute: 316L stainless steel
- Impeller: CF8M (316) stainless steel
- Backplate: 316L stainless steel
- Stub Shaft: 316L stainless steel
- Adapter: 304 stainless steel
- Optional Leg Kit: 304 stainless steel
- Seal Types: externally balanced 'D','DG', and 'F' with clamped in seat
- Rotary Seal Material: carbon and silicon carbide
- 'DG' Seal Seat Material: silicon carbide, ceramic and tungsten carbide
- Elastomers: Buna, EPDM, silicone and FKM
- Finish: sanitary polish 32RA

## Performance Characteristics

- Nominal Capacity: up to 1200 GPM
- Temperature: 32°F to 212°F, consult Dixon Sanitary for other temperatures
- Nominal speed: up to 3500 RPM - 60 Hz
- Viscosity Range: 0-500cP

## Motors and Mounting

- Motor: standard C-face, 1750 and 3450 RPM, TEFC and washdown, foot mounted
- Additional motor types available upon request
- Mounting: pump head mounted to a C-Face motor

## Family of Curves

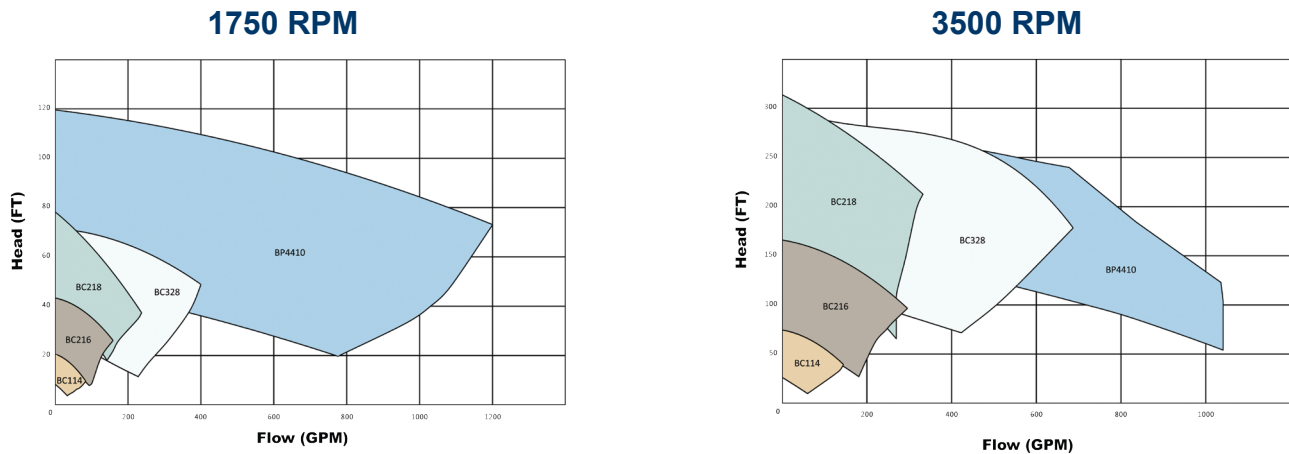

## BC/BP-Series Sanitary Centrifugal Pumps

### Seal Options

#### D Seal

External Balanced

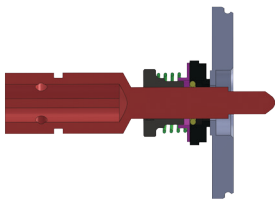

- optional silicon carbide
- carbon rotating element on stationary stainless steel
- suitable for sanitary and industrial applications where fluid is non-abrasive and lubricating
- N/A on 441 and 641 models

#### F Seal

External Balanced

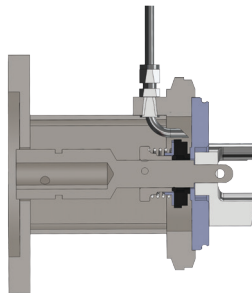

- Externally balanced D or DG Seal with water cascade for use when normal D seal applications include product temperatures that reach 212°F or when the fluid is sticky or tacky.

#### DG Seal

Clamped-In Seat

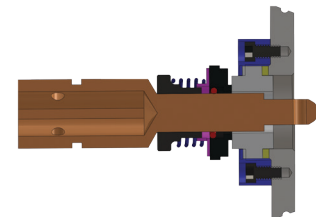

- choose from ceramic, silicon carbide and tungsten carbide as the stationary seal
- suitable for the majority of sanitary applications, including those using non-lubricating and abrasive fluids
- carbon rotating element on encapsulated seat; optional silicon rotating element is available

## BC Vs. BP

- hydraulic performance the same as the BC-Series
- no changes to external dimensions
- all other parts interchangeable
- can modify your existing stub shaft
- offered in all sizes
- same day delivery

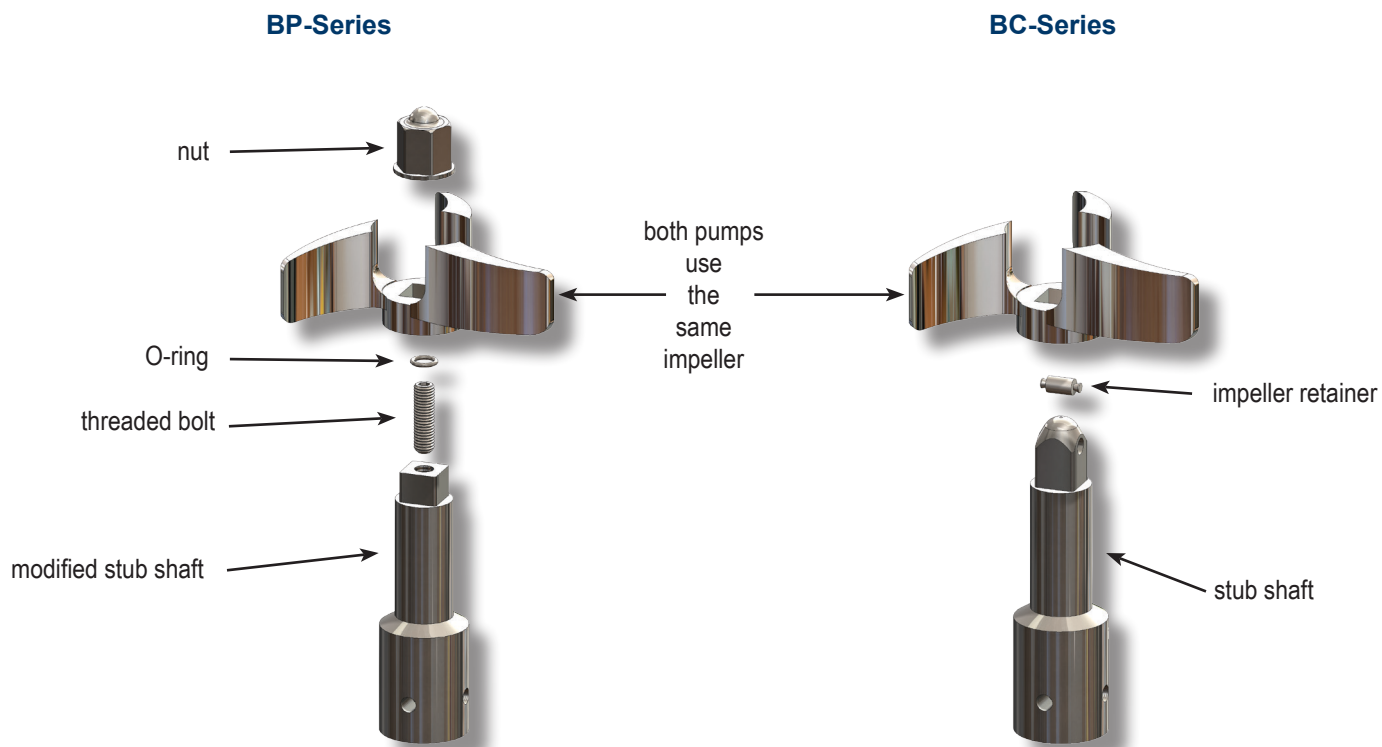

## How to Read a Curve

- A:** This section references the size of the pump, speed, frequency and the model number.
- B:** y axis, shows head in feet
- C:** x axis, shows flow in GPM
- D:** These solid line curves are for specific impeller diameters.
- E:** The dotted line curves are for motor horsepower requirements.
- F:** Duty point, where the flow and head requirements intersect.
- G:** NPSH required for the duty point.

Example:

72 GPM @ 40' Head of water

Find 72 GPM on the curve and then go upwards until you hit the line that is 40' of head on the impeller trim curves. This determines what impeller diameter is needed for your application. This is your duty point as labeled F. To determine the horsepower required, from the duty point go towards the right to the closest dotted horsepower curve and that will be the size of motor you will need. To determine the NPSH required, from the duty point, draw a line straight downward and where that intersects is the NPSH required in feet. That figure is on the y axis in feet.

In this example the pump you would select would be:

Model No. BC114, 3.5" impeller diameter, driven by a 1½ HP, 3500 RPM motor, NPSHr would be 8'.



Size: 1.5 x 1.5 x 4  
 RPM: 3500  
 Frequency: 60 Hz  
 Model #: BC114



# BC Series Centrifugal Pump

PERFORMANCE CURVES (Based on H<sub>2</sub>O @ 70° F)

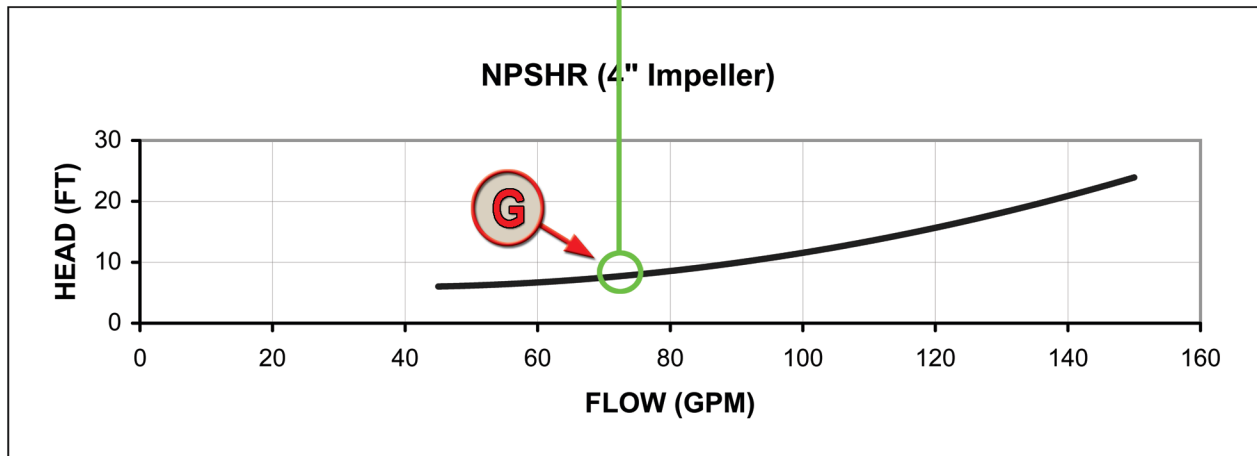
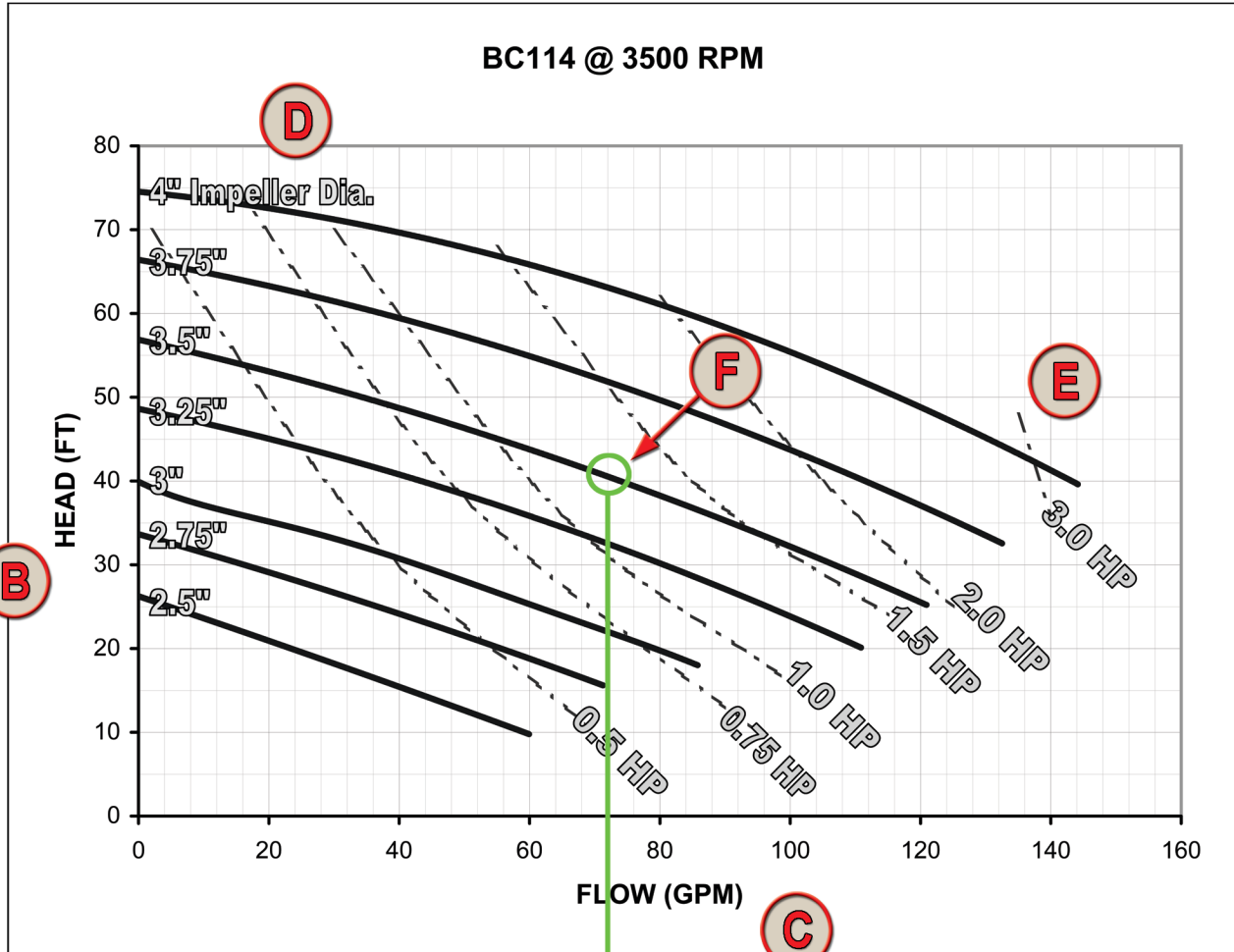

## BC-Series Sanitary Centrifugal Pump



The Right Connection®

Size: 1.5 x 1.5 x 4  
 RPM: 1750  
 Frequency: 60 Hz  
 Model #: BC114

### BC Series Centrifugal Pump

PERFORMANCE CURVES (Based on H<sub>2</sub>O @ 70° F)

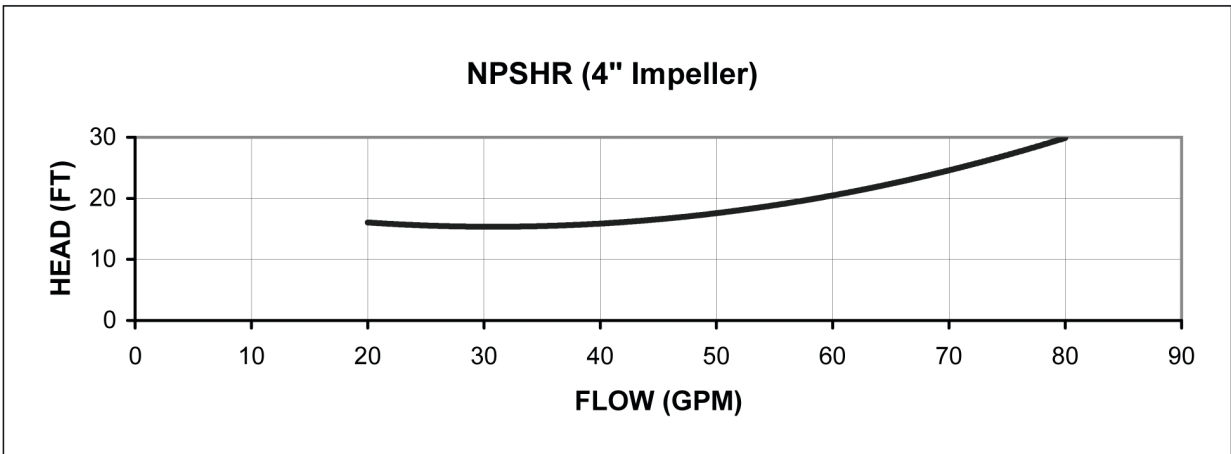
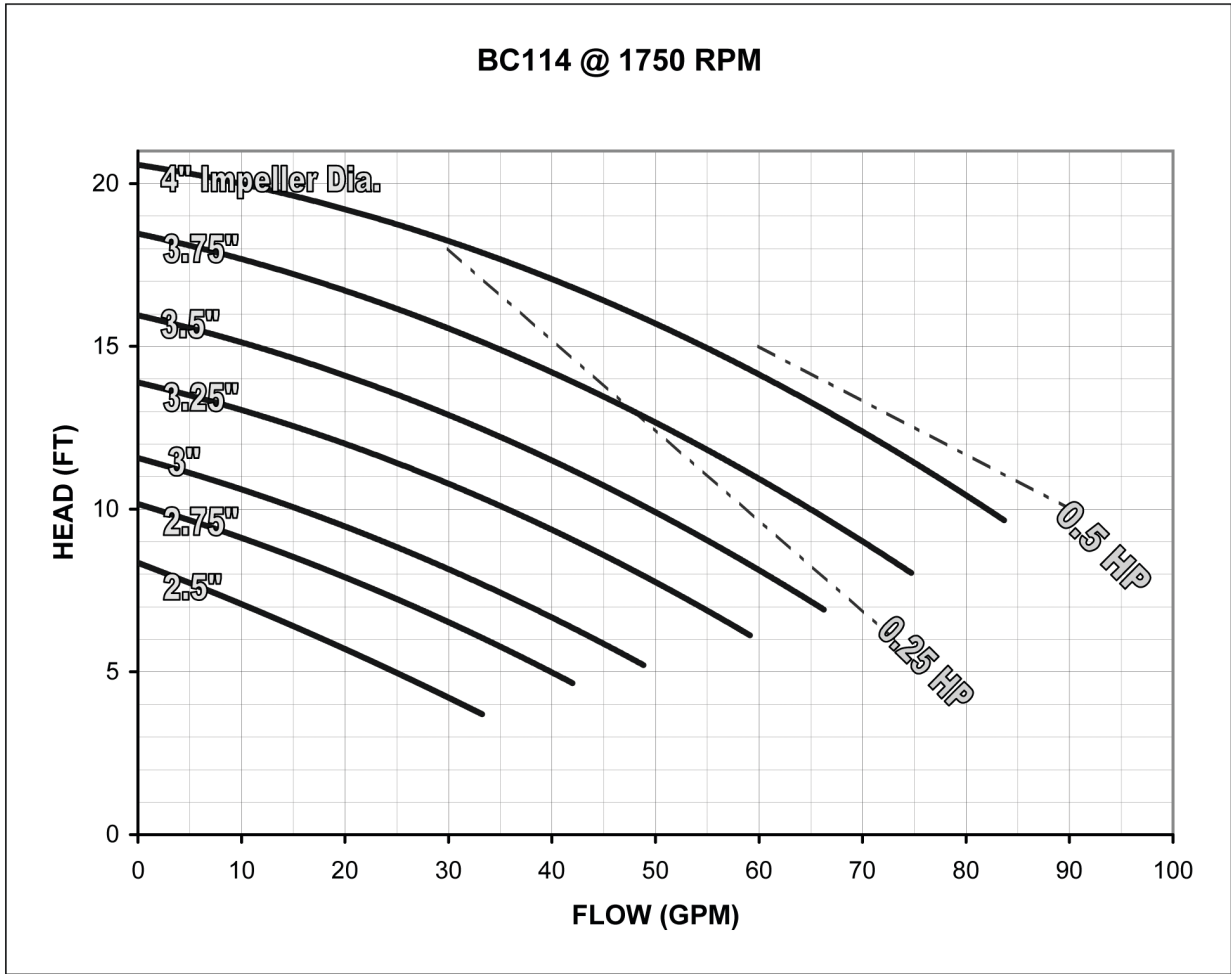

# BC-Series Sanitary Centrifugal Pump



The Right Connection®

## BC Series Centrifugal Pump

Size: 1.5 x 1.5 x 4  
 RPM: 3500  
 Frequency: 60 Hz  
 Model #: BC114

PERFORMANCE CURVES (Based on H<sub>2</sub>O @ 70° F)

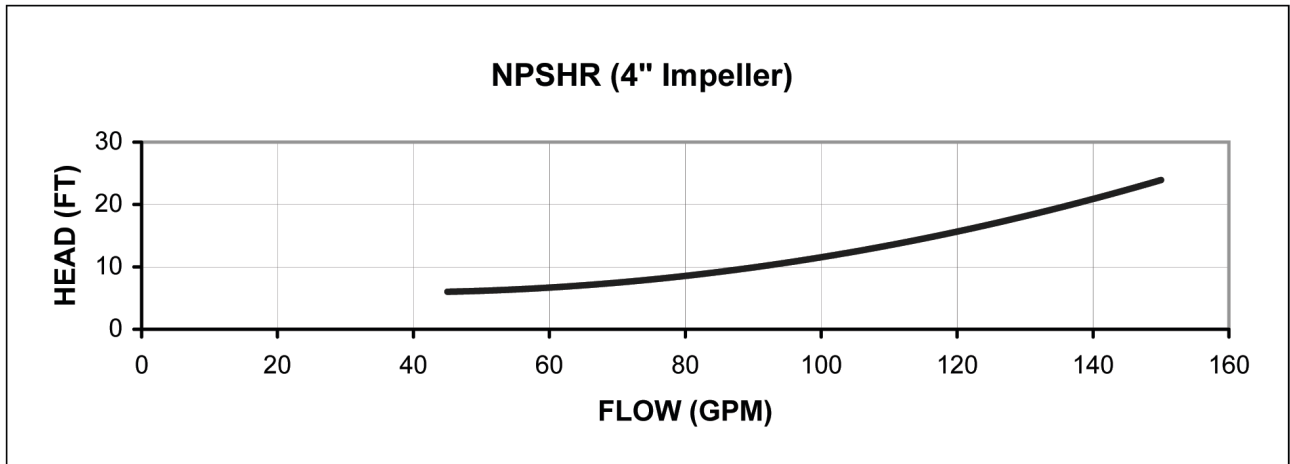
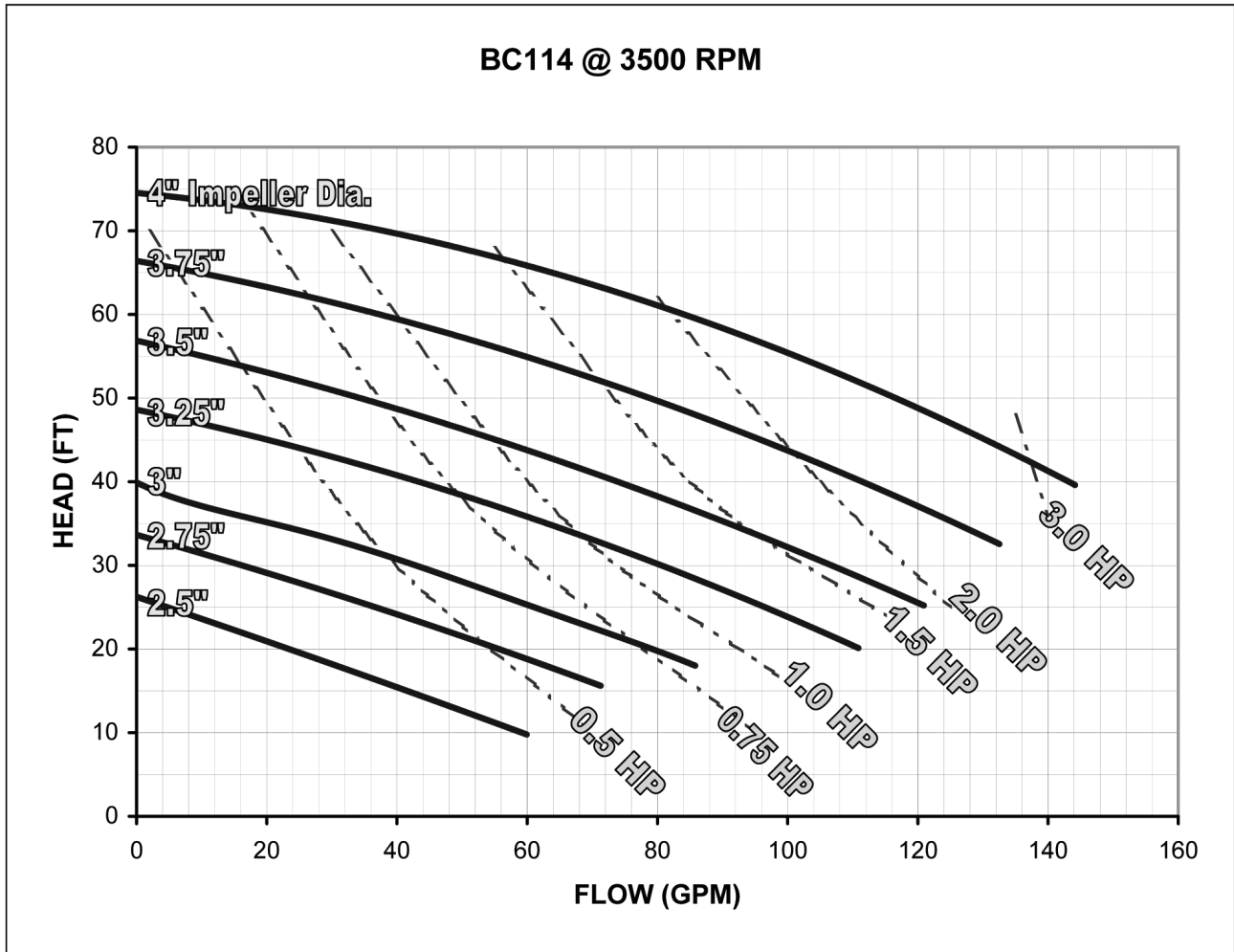



# BC-Series Sanitary Centrifugal Pump



The Right Connection®

## BC Series Centrifugal Pump

PERFORMANCE CURVES (Based on H<sub>2</sub>O @ 70° F)

Size: 2 x 1.5 x 4  
 RPM: 1750  
 Frequency: 60 Hz  
 Model #: BC214

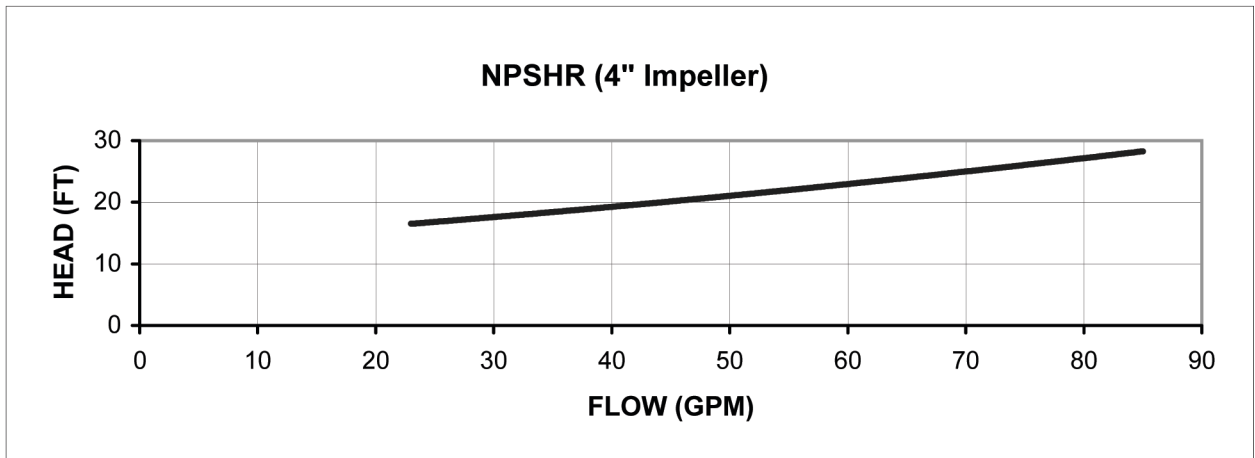
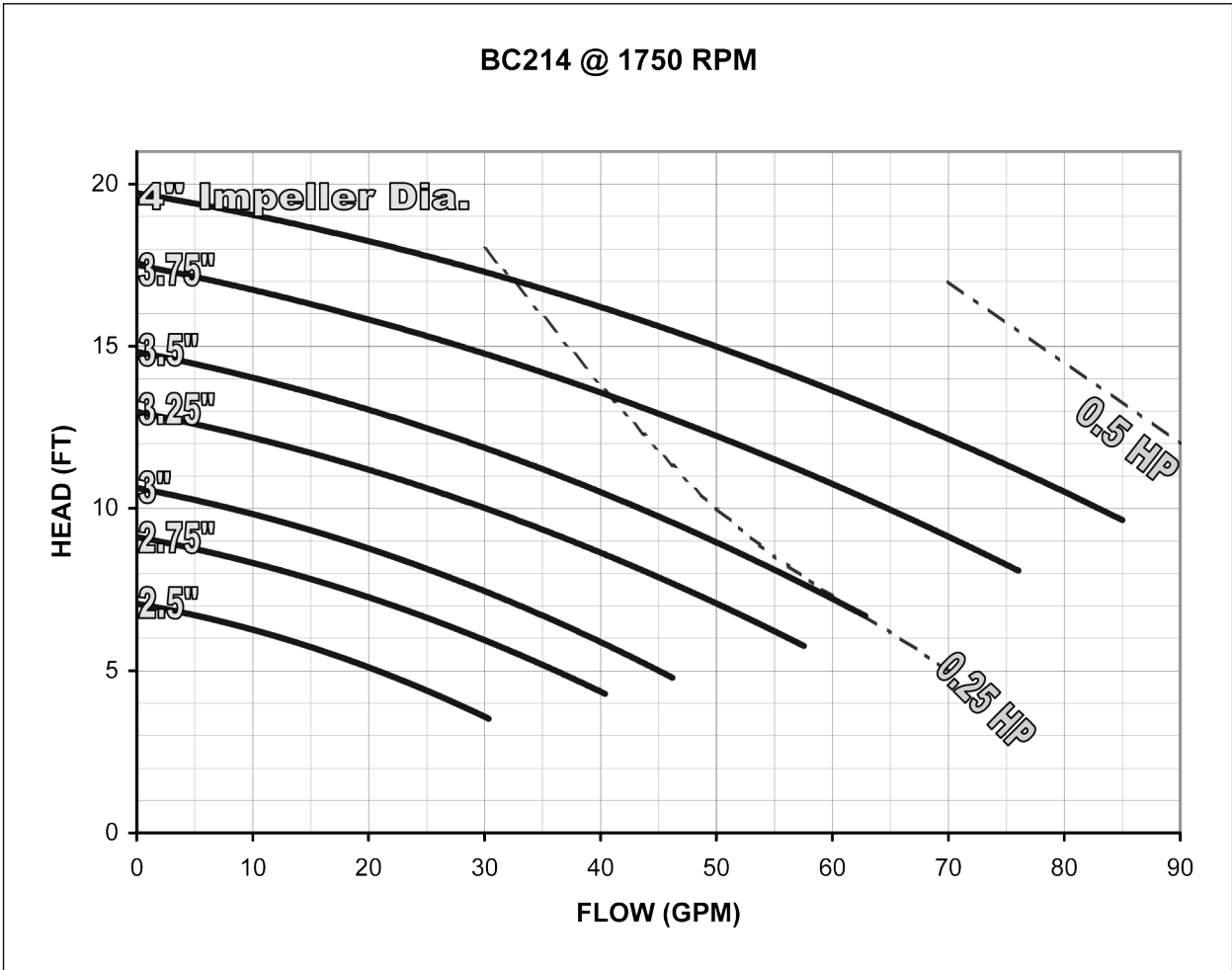

# BC-Series Sanitary Centrifugal Pump



The Right Connection®

## BC Series Centrifugal Pump

PERFORMANCE CURVES (Based on H<sub>2</sub>O @ 70° F)

Size: 2 x 1.5 x 4  
 RPM: 3500  
 Frequency: 60 Hz  
 Model #: BC214

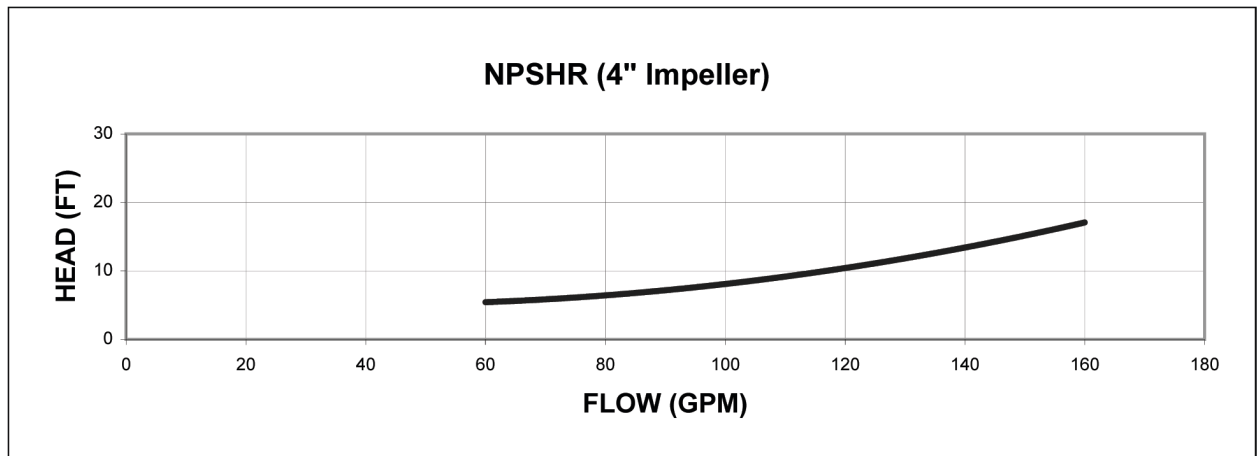
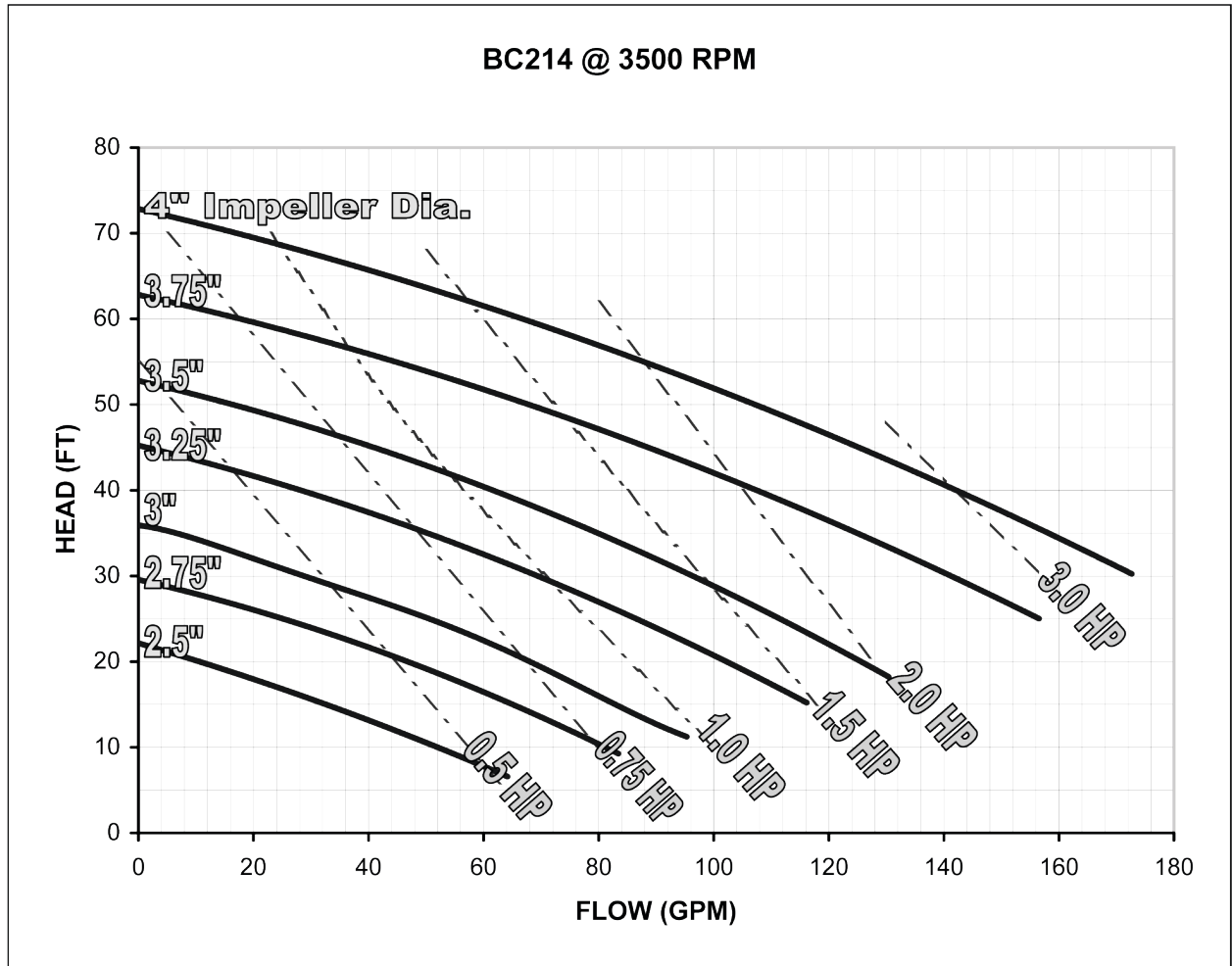

# BC-Series Sanitary Centrifugal Pump



The Right Connection®

## BC Series Centrifugal Pump

PERFORMANCE CURVES (Based on H<sub>2</sub>O @ 70° F)

Size: 2 x 1.5 x 6  
 RPM: 1750  
 Frequency: 60 Hz  
 Model #: BC216

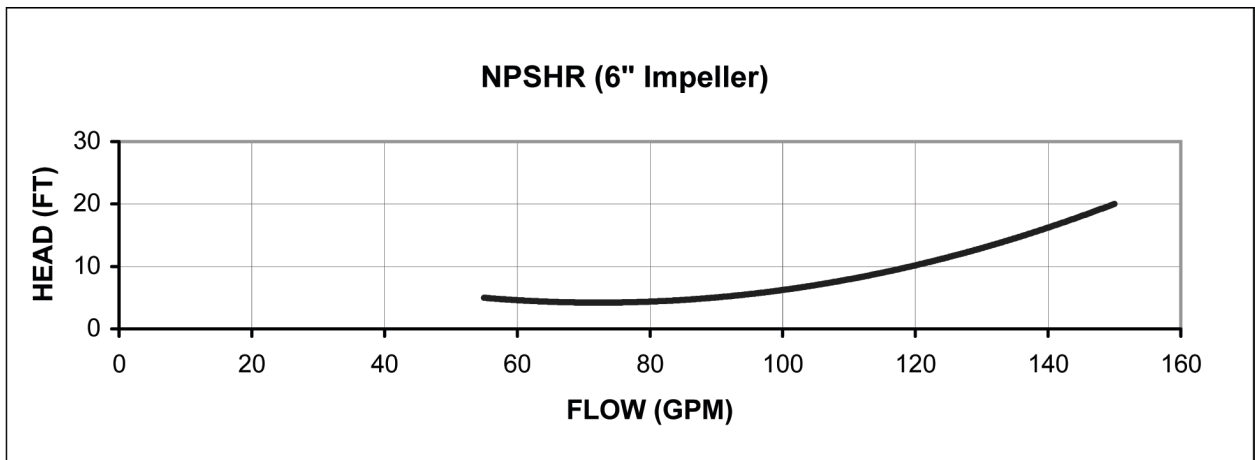
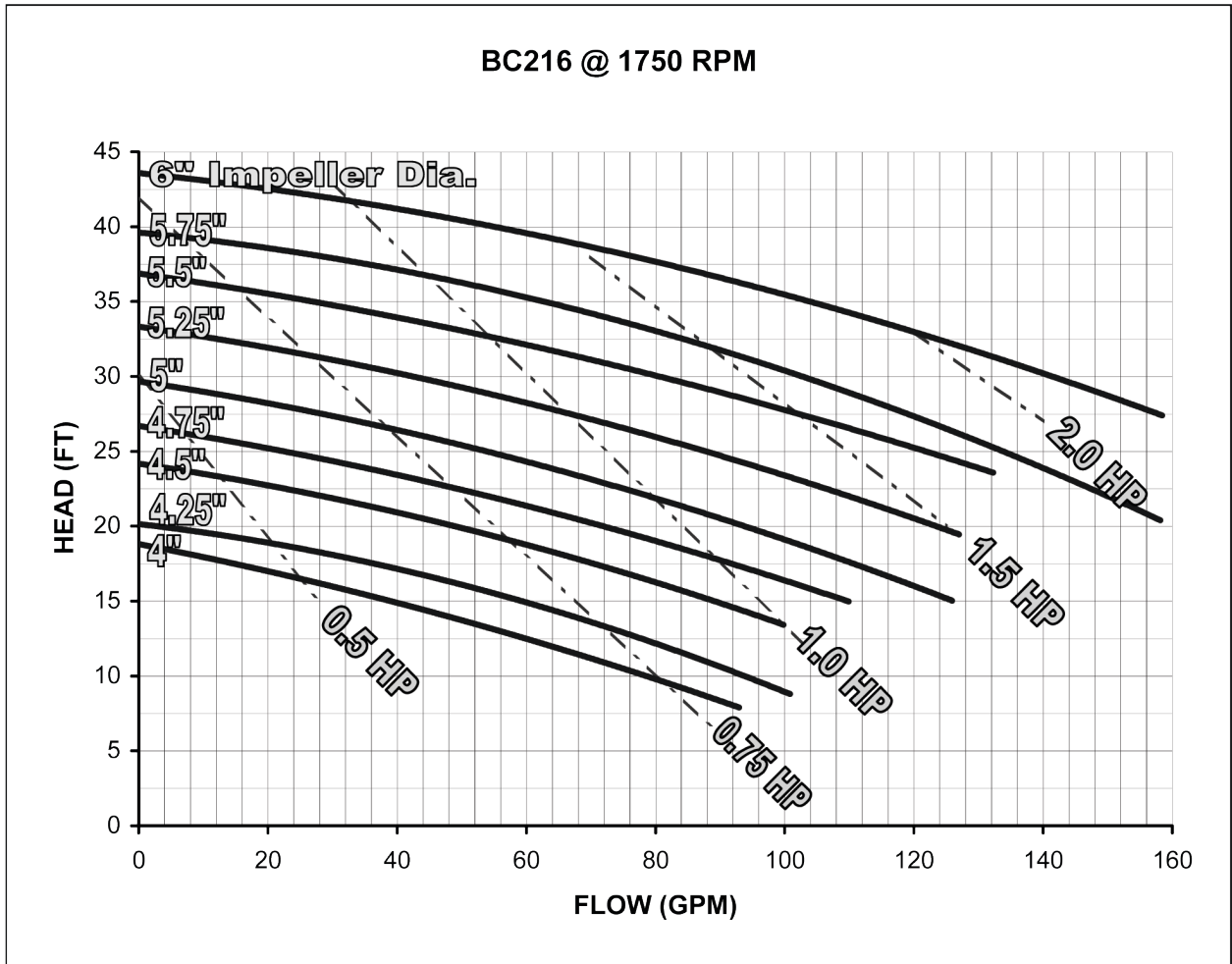

# BC-Series Sanitary Centrifugal Pump



The Right Connection®

Size: 2 x 1.5 x 6  
 RPM: 3500  
 Frequency: 60 Hz  
 Model #: BC216

## BC Series Centrifugal Pump

PERFORMANCE CURVES (Based on H<sub>2</sub>O @ 70° F)

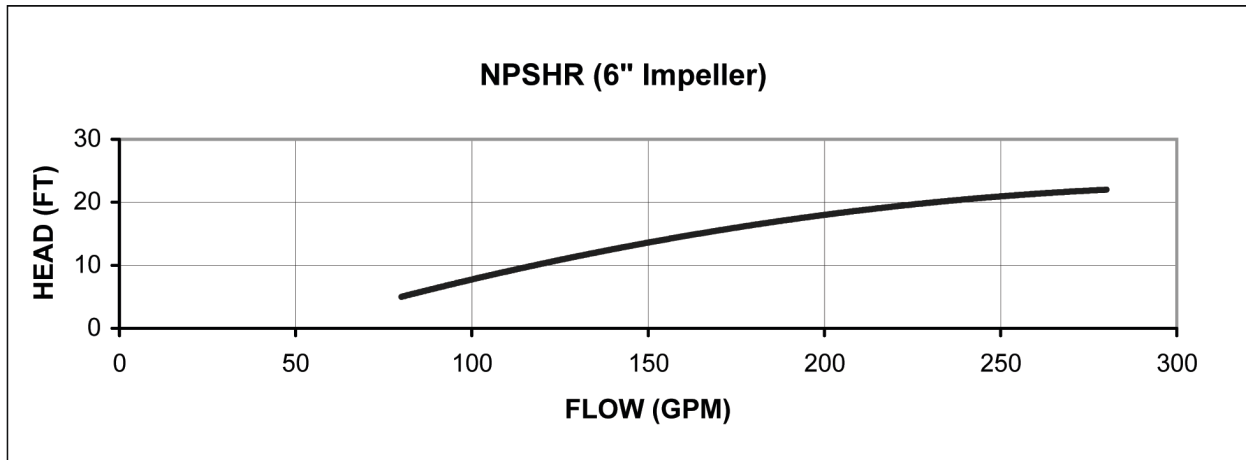
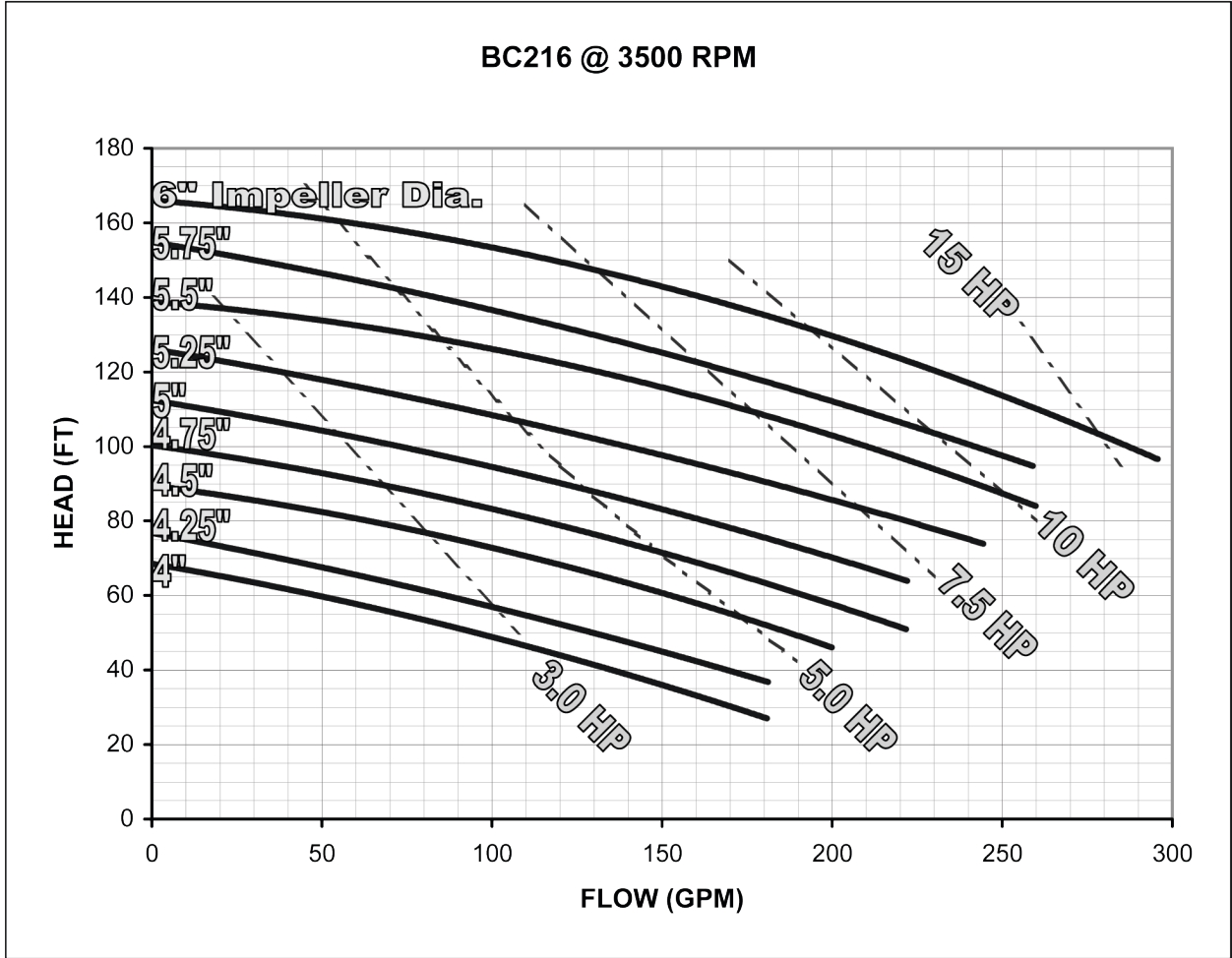

# BC-Series Sanitary Centrifugal Pump



The Right Connection®

## BC Series Centrifugal Pump

Size: 2.5 x 1.5 x 6  
 RPM: 1750  
 Frequency: 60 Hz  
 Model #: BC516

PERFORMANCE CURVES (Based on H<sub>2</sub>O @ 70° F)

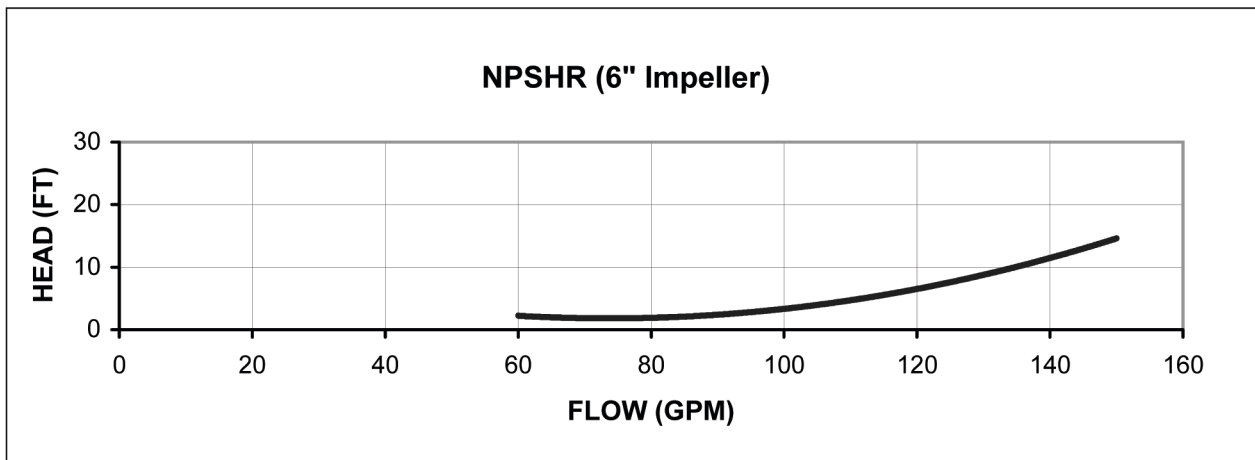
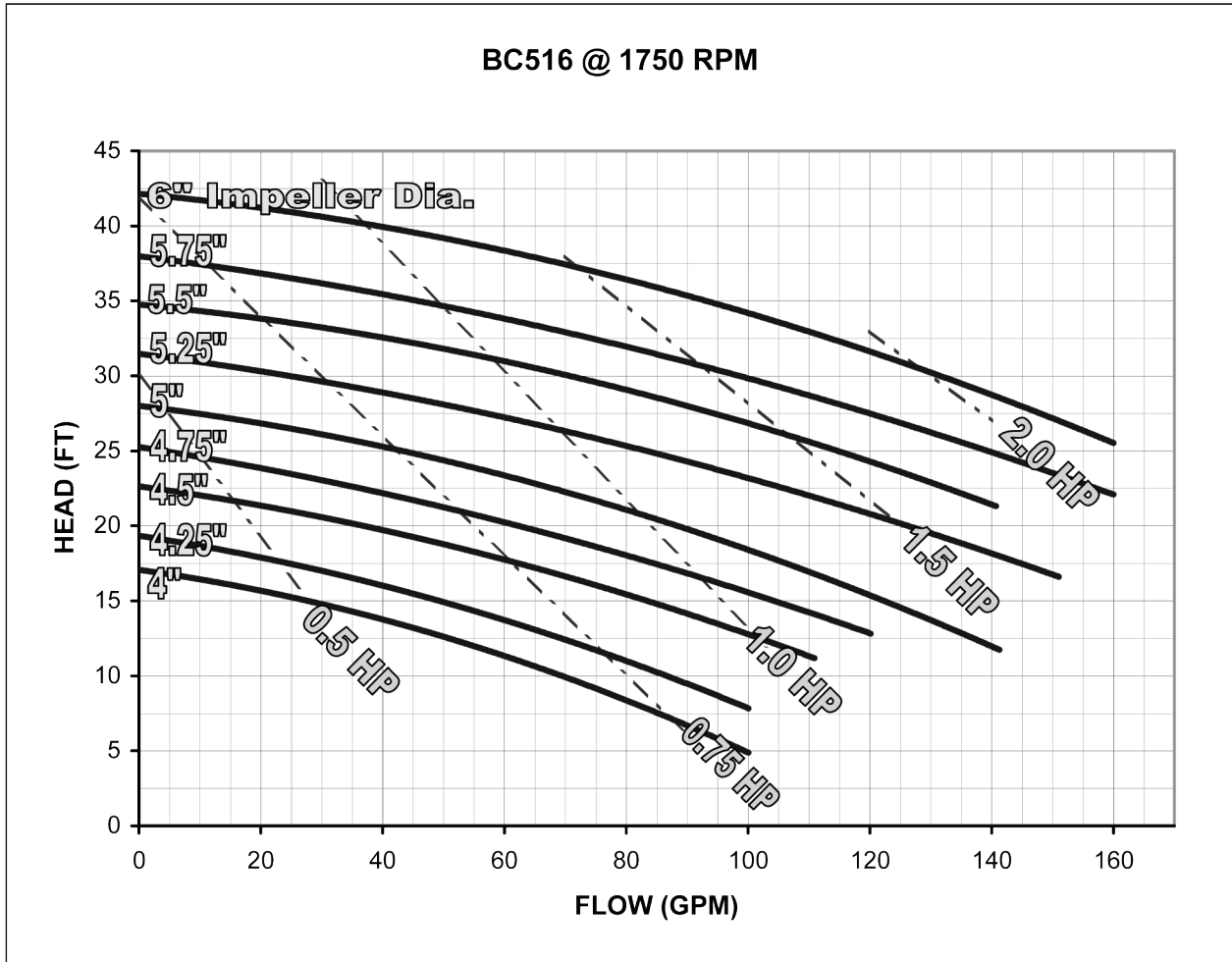

# BC-Series Sanitary Centrifugal Pump



The Right Connection®

## BC Series Centrifugal Pump

PERFORMANCE CURVES (Based on H<sub>2</sub>O @ 70° F)

Size: 2.5 x 1.5 x 6  
 RPM: 3500  
 Frequency: 60 Hz  
 Model #: BC516

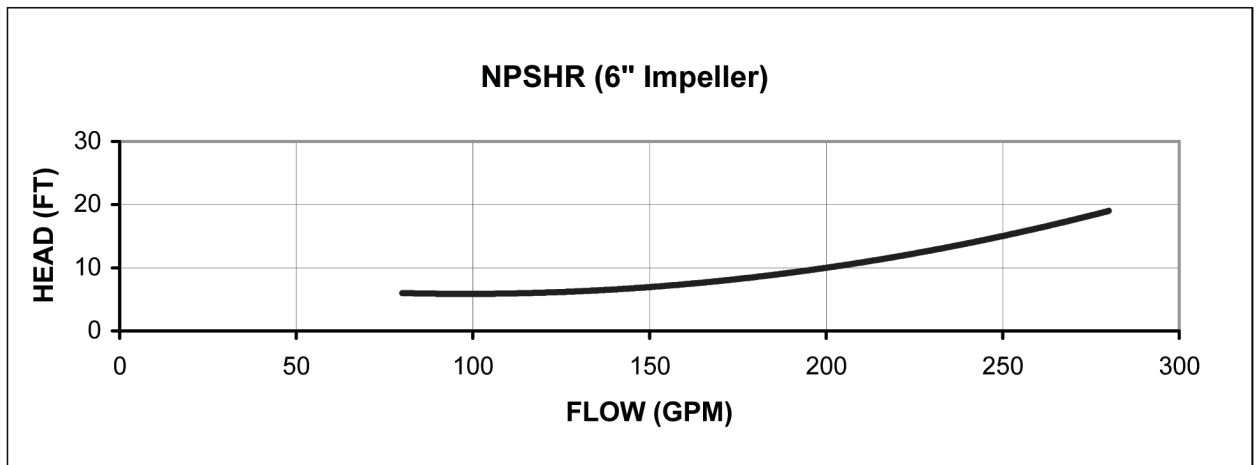
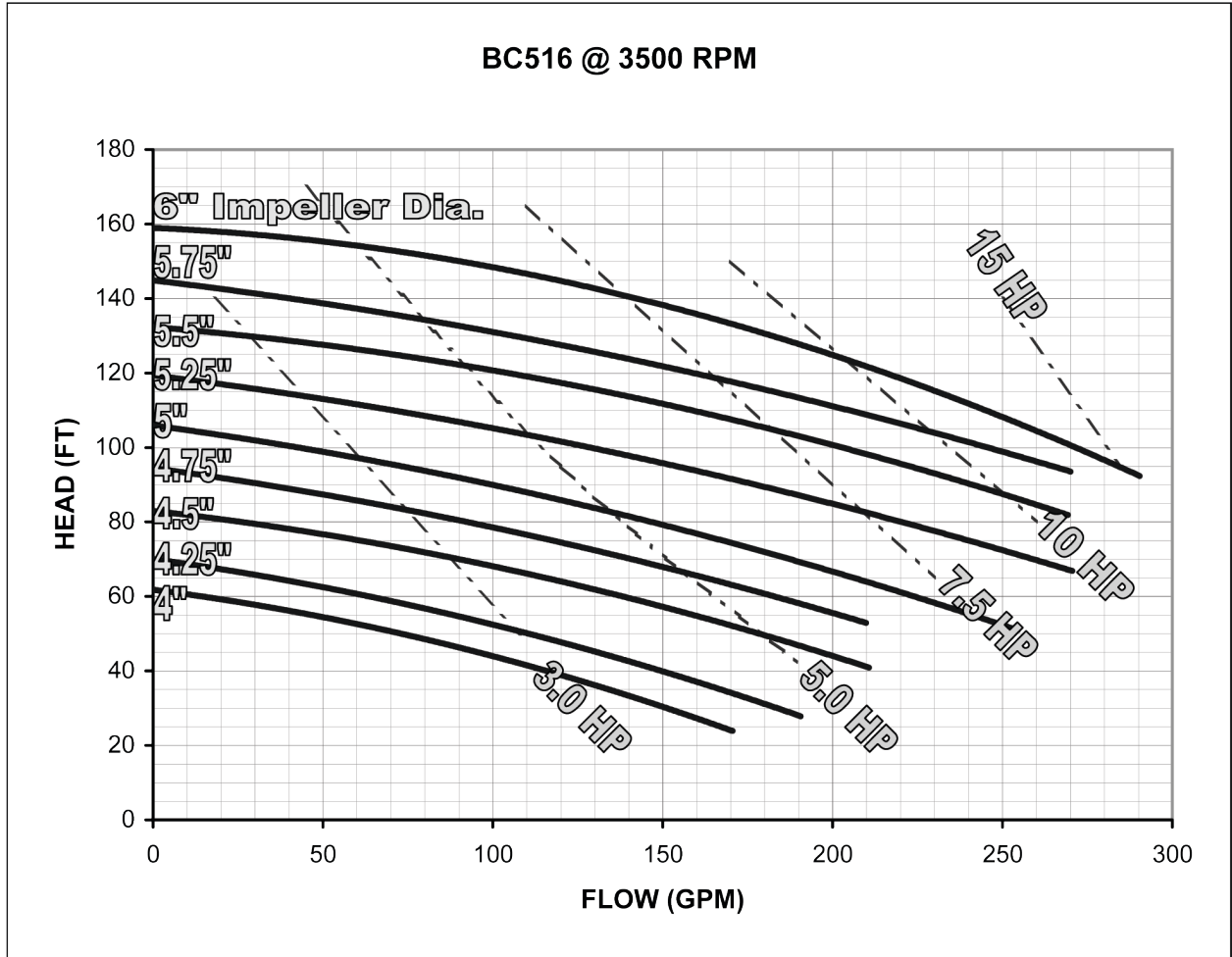

# BC-Series Sanitary Centrifugal Pump



The Right Connection®

## BC Series Centrifugal Pump

PERFORMANCE CURVES (Based on H<sub>2</sub>O @ 70° F)

Size: 2 x 1.5 x 8  
 RPM: 1750  
 Frequency: 60 Hz  
 Model #: BC218

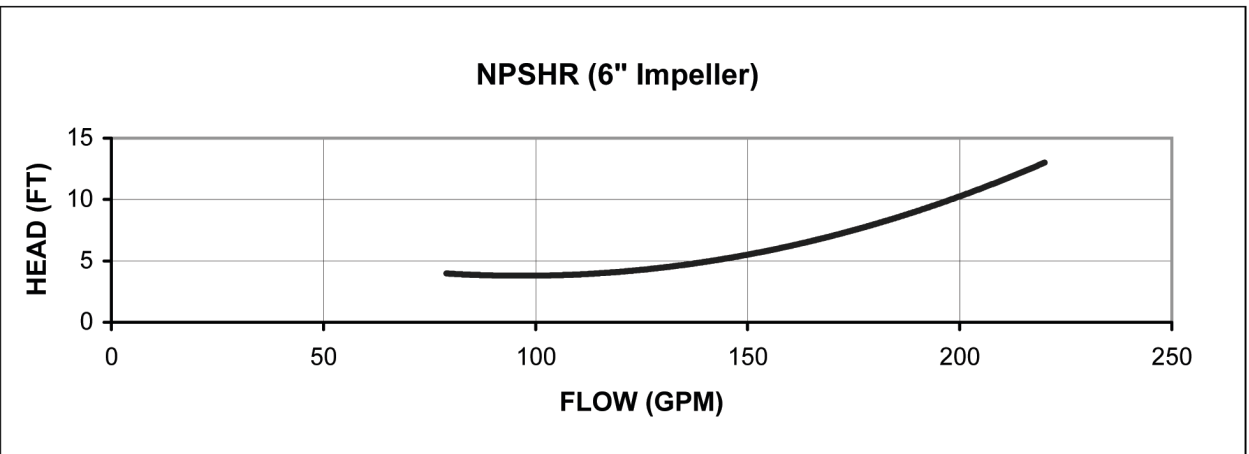
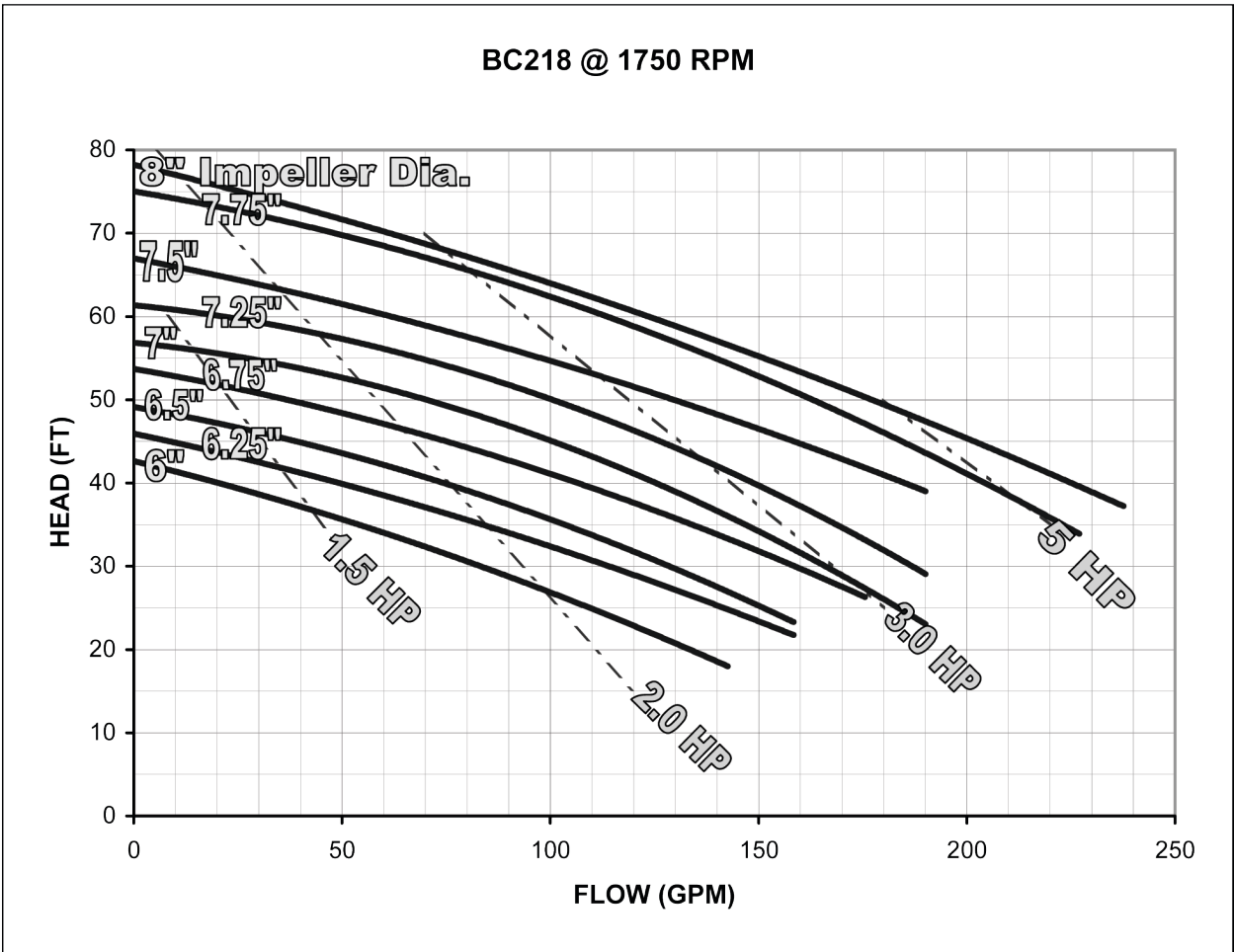

# BC-Series Sanitary Centrifugal Pump



The Right Connection®

## BC Series Centrifugal Pump

PERFORMANCE CURVES (Based on H<sub>2</sub>O @ 70° F)

Size: 2 x 1.5 x 8  
 RPM: 3500  
 Frequency: 60 Hz  
 Model #: BC218

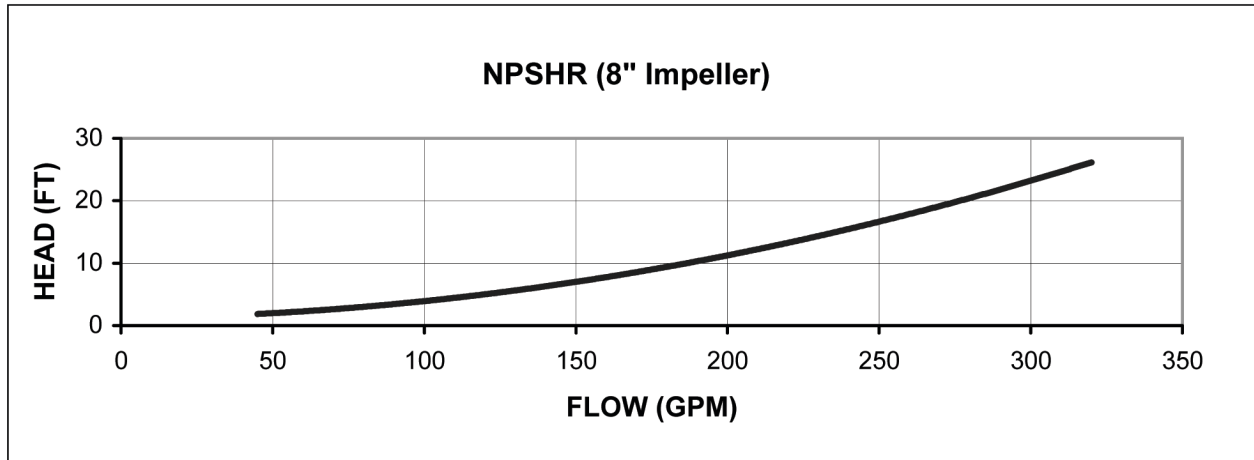
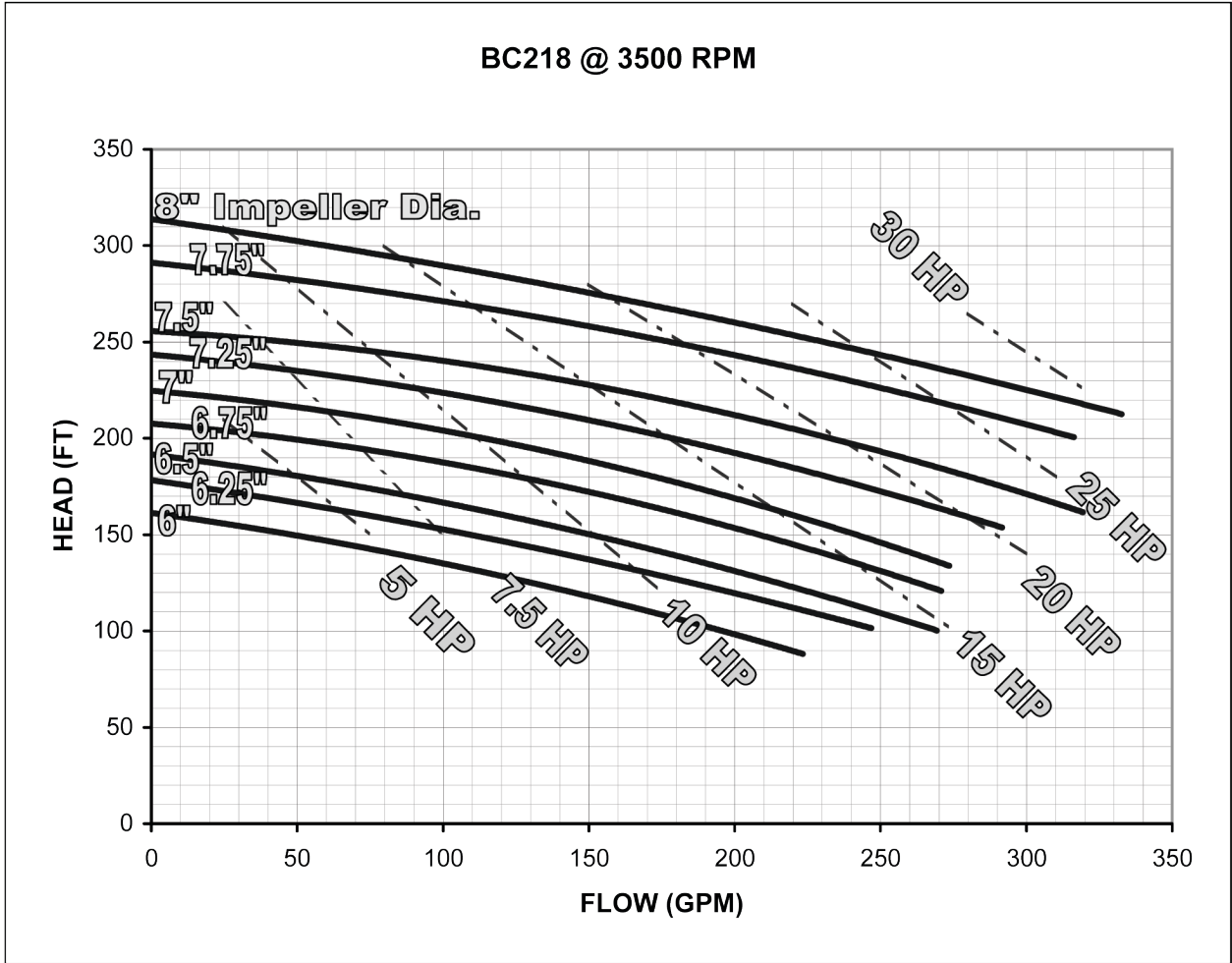



# BC-Series Sanitary Centrifugal Pump



The Right Connection®

Size: 3 x 1.5 x 8  
 RPM: 1750  
 Frequency: 60 Hz  
 Model #: BC318

## BC Series Centrifugal Pump

PERFORMANCE CURVES (Based on H<sub>2</sub>O @ 70° F)

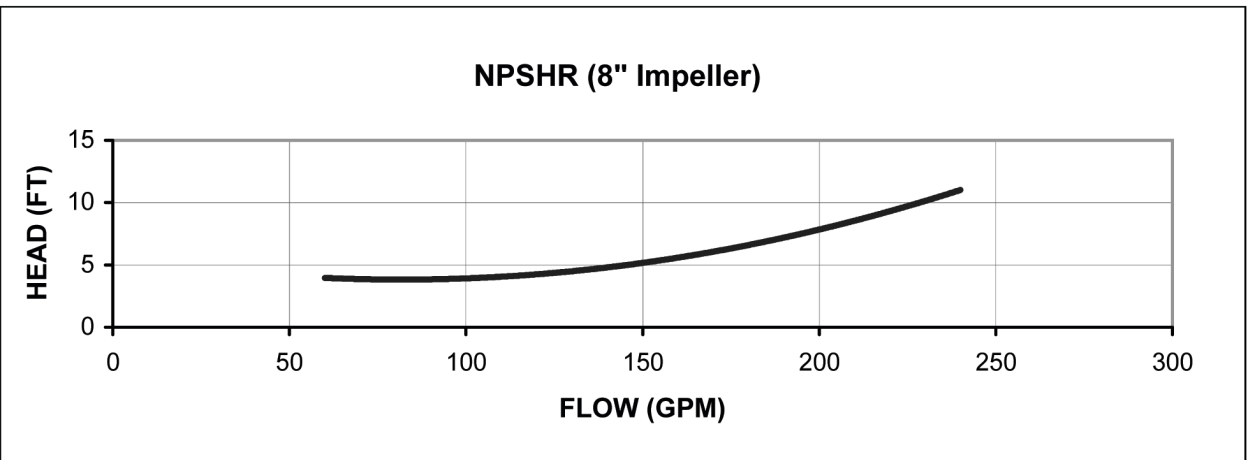
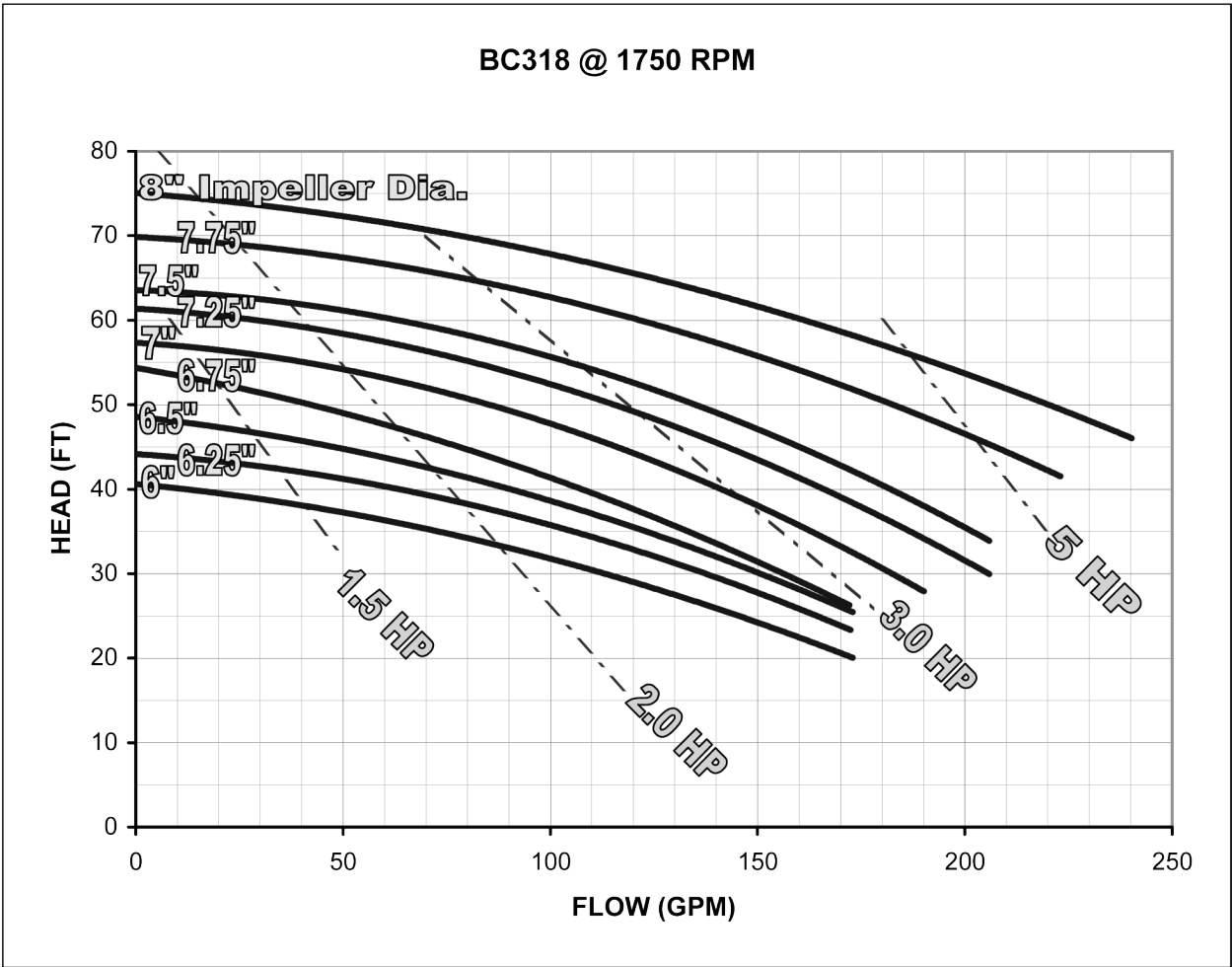

# BC-Series Sanitary Centrifugal Pump



The Right Connection®

## BC Series Centrifugal Pump

PERFORMANCE CURVES (Based on H<sub>2</sub>O @ 70° F)

Size: 3 x 1.5 x 8  
 RPM: 3500  
 Frequency: 60 Hz  
 Model #: BC318

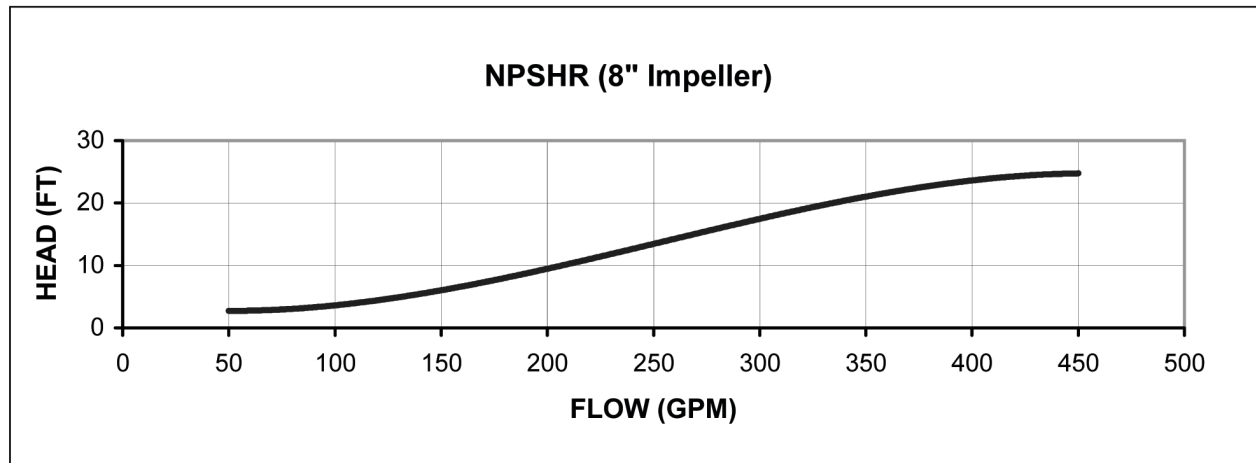
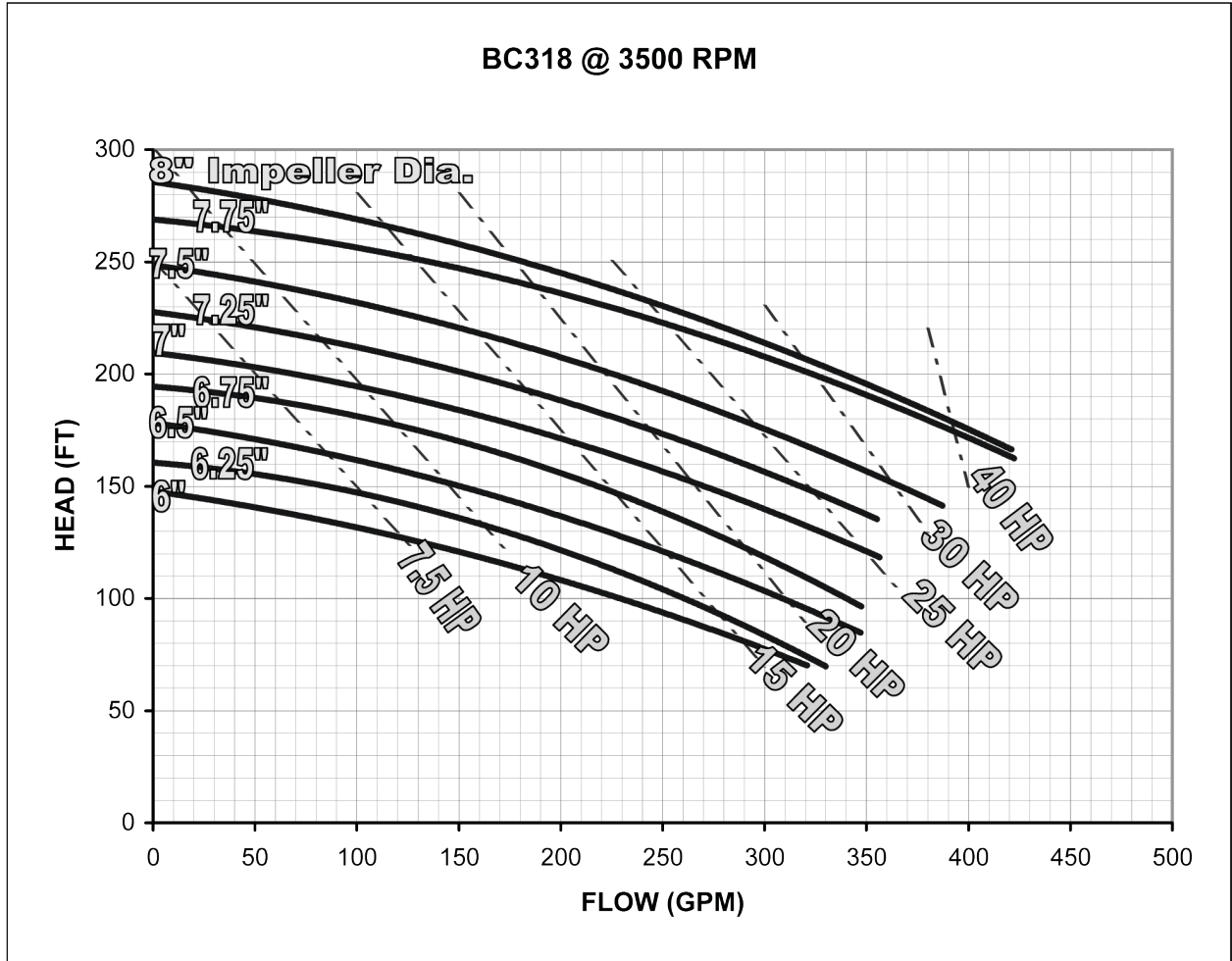

# BC-Series Sanitary Centrifugal Pump



The Right Connection®

## BC Series Centrifugal Pump

PERFORMANCE CURVES (Based on H<sub>2</sub>O @ 70° F)

Size: 3 x 2 x 8  
 RPM: 1750  
 Frequency: 60 Hz  
 Model #: BC328

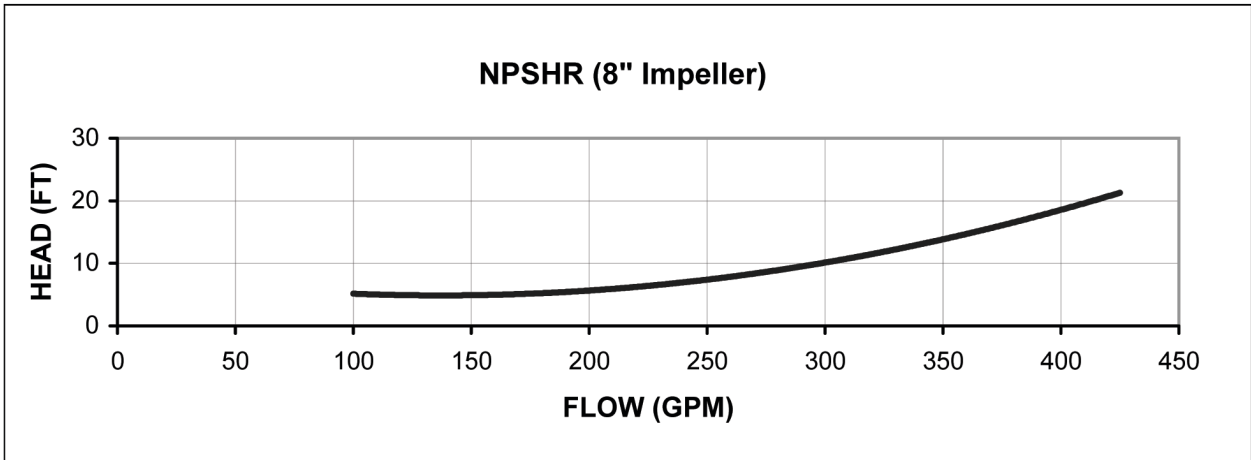
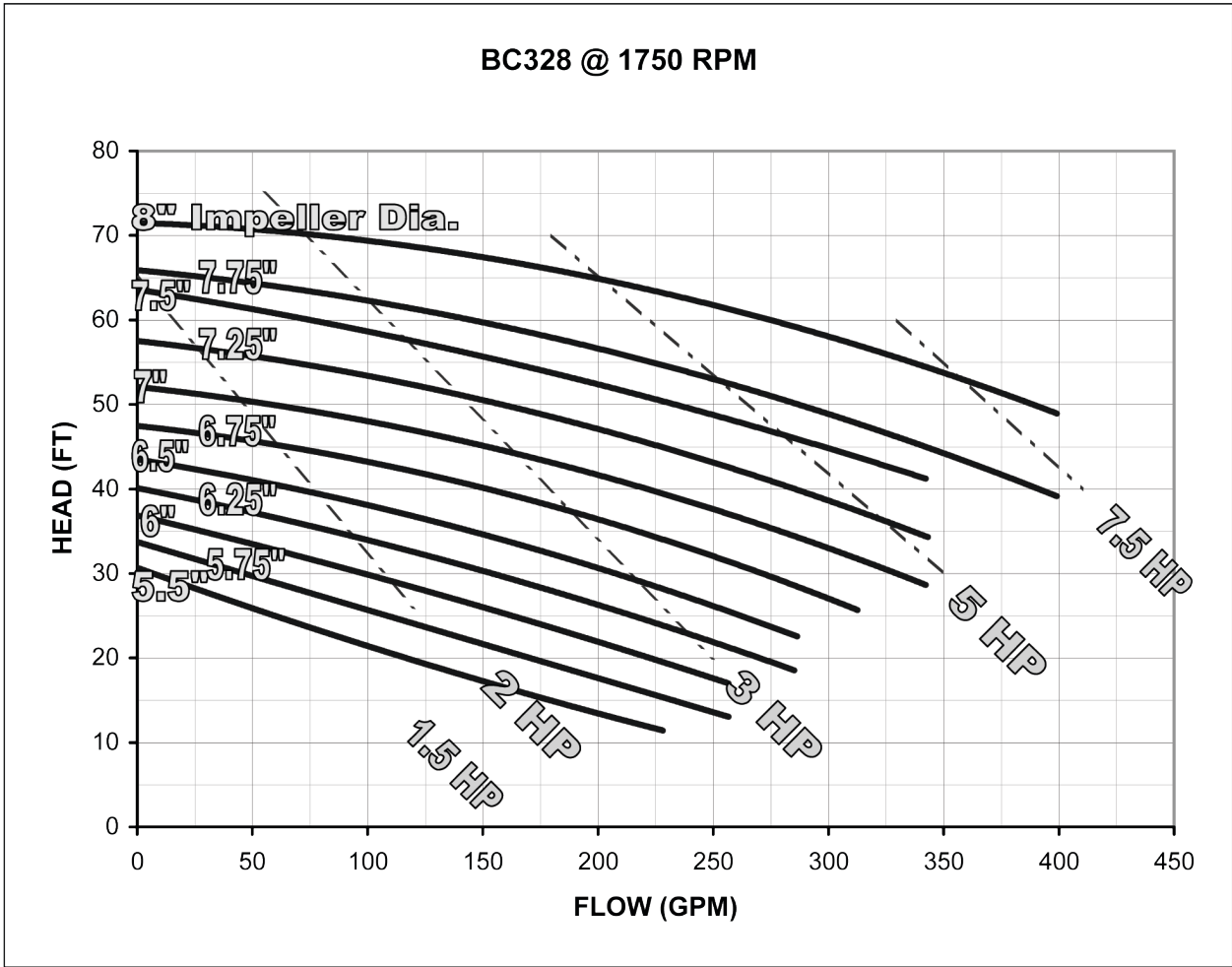

# BC-Series Sanitary Centrifugal Pump



The Right Connection®

## BC Series Centrifugal Pump

PERFORMANCE CURVES (Based on H<sub>2</sub>O @ 70° F)

Size: 3 x 2 x 8  
 RPM: 3500  
 Frequency: 60 Hz  
 Model #: BC328

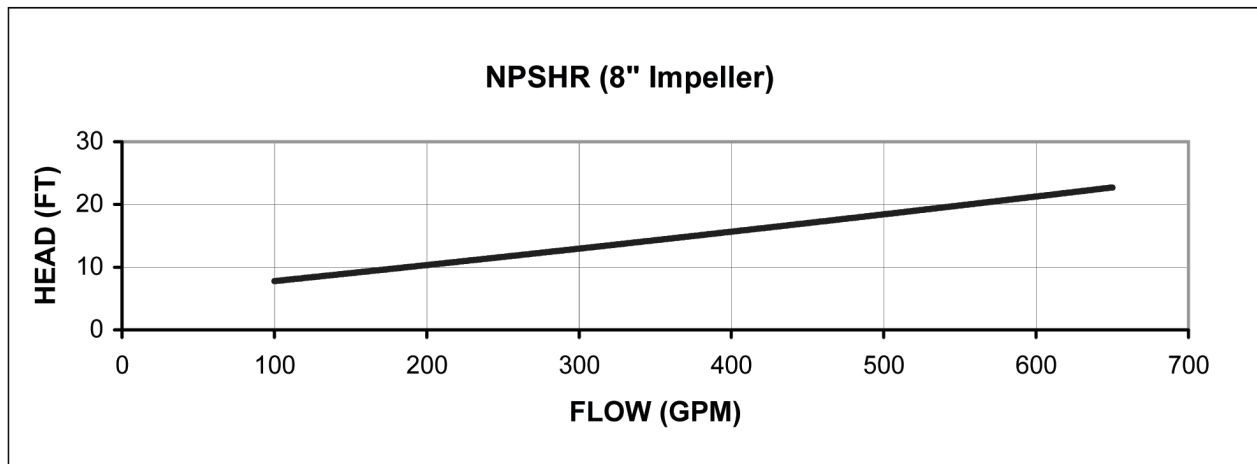
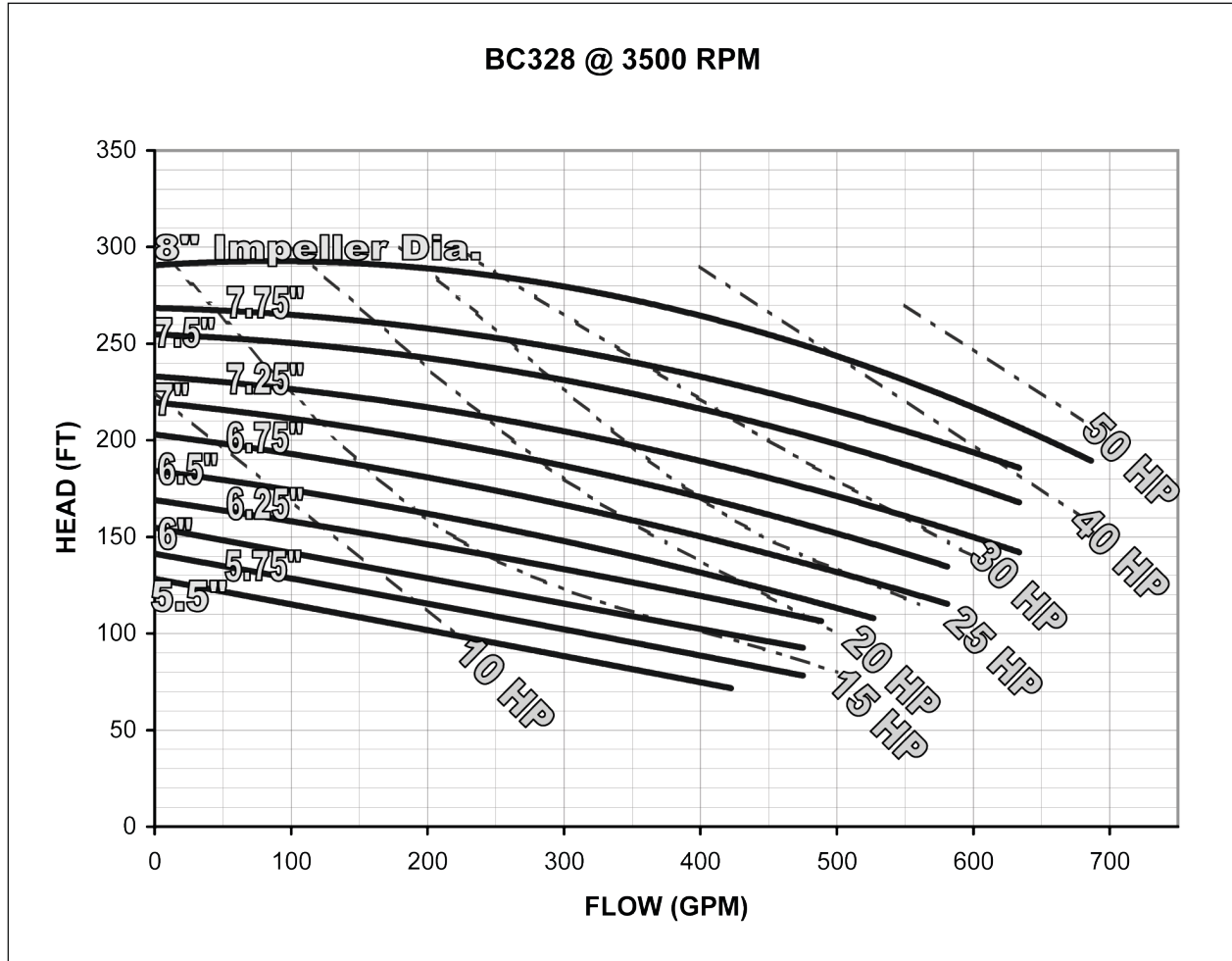

# BC-Series Sanitary Centrifugal Pump



The Right Connection®

## BC Series Centrifugal Pump

PERFORMANCE CURVES (Based on H<sub>2</sub>O @ 70° F)

Size: 4 x 2 x 8  
 RPM: 1750  
 Frequency: 60 Hz  
 Model #: BC428

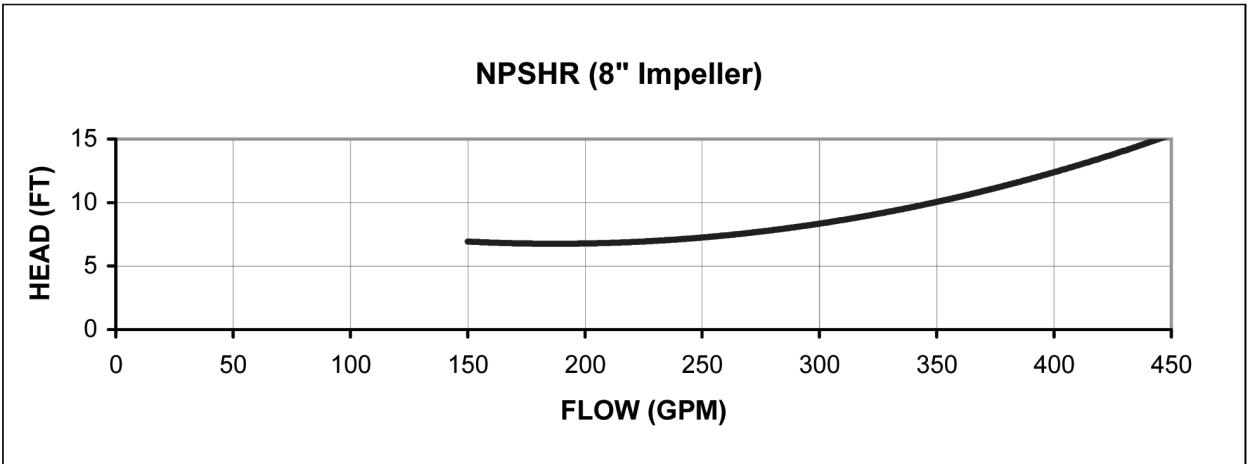
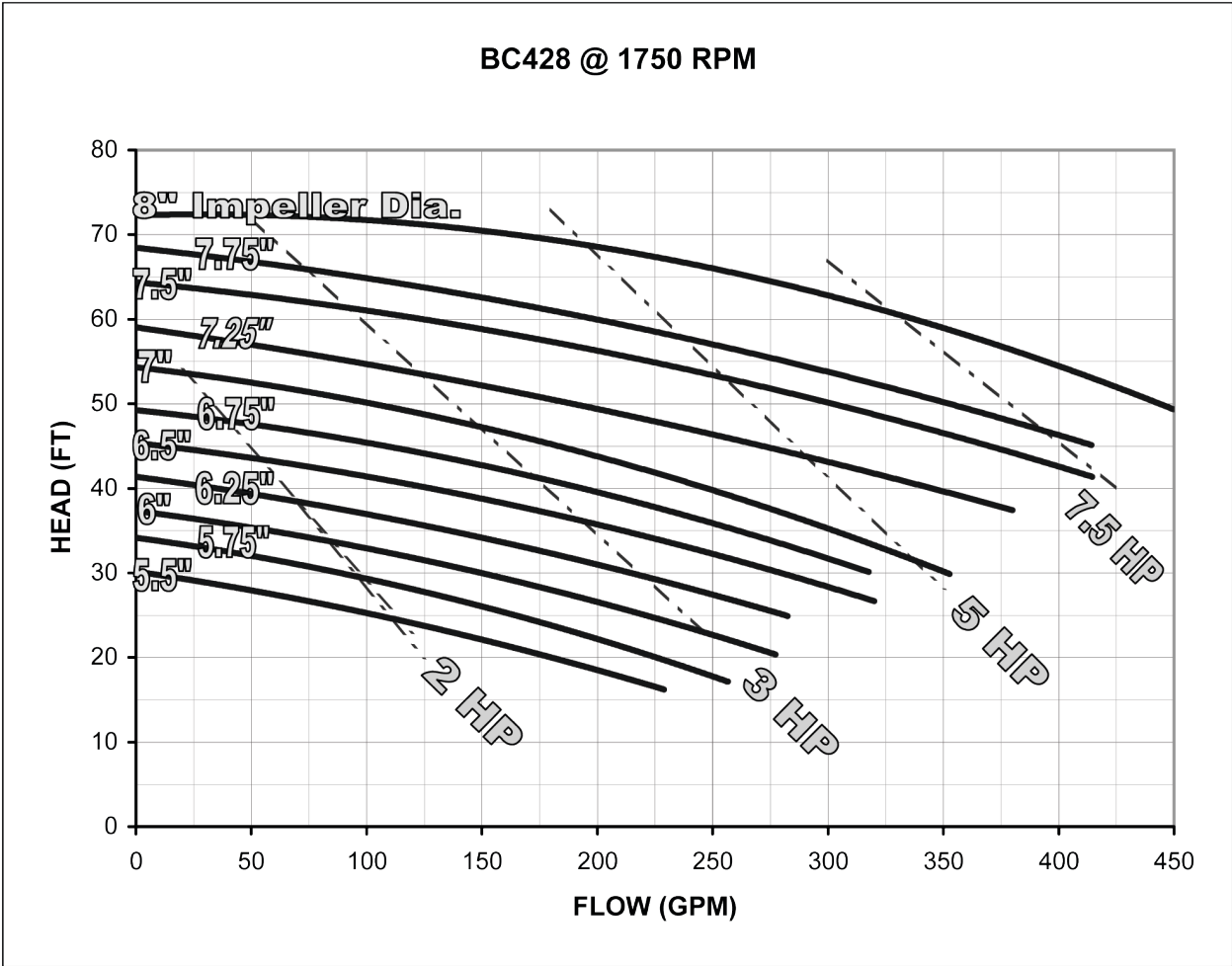

# BC-Series Sanitary Centrifugal Pump



The Right Connection®

## BC Series Centrifugal Pump

Size: 4 x 2 x 8  
 RPM: 3500  
 Frequency: 60 Hz  
 Model #: BC428

PERFORMANCE CURVES (Based on H<sub>2</sub>O @ 70° F)

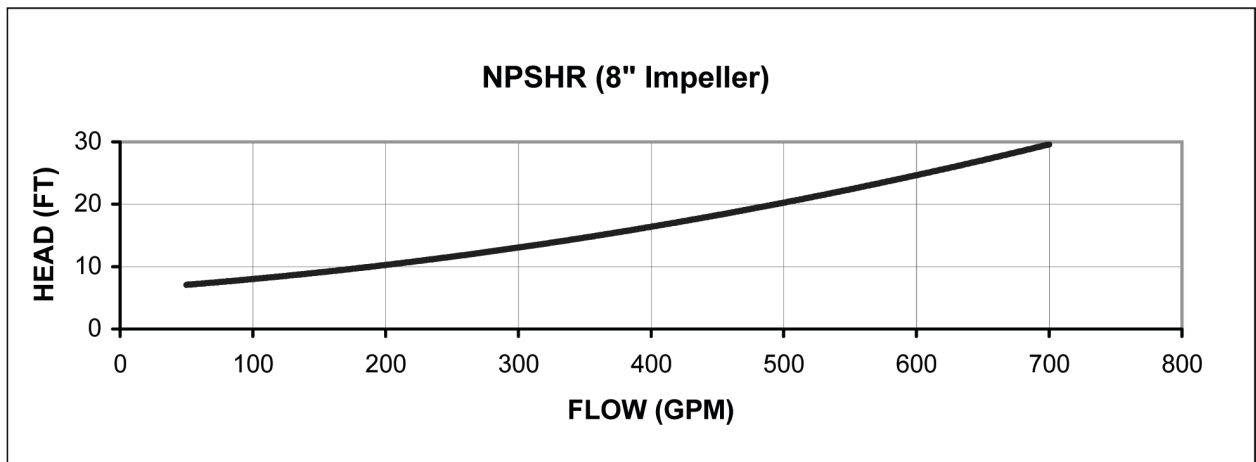
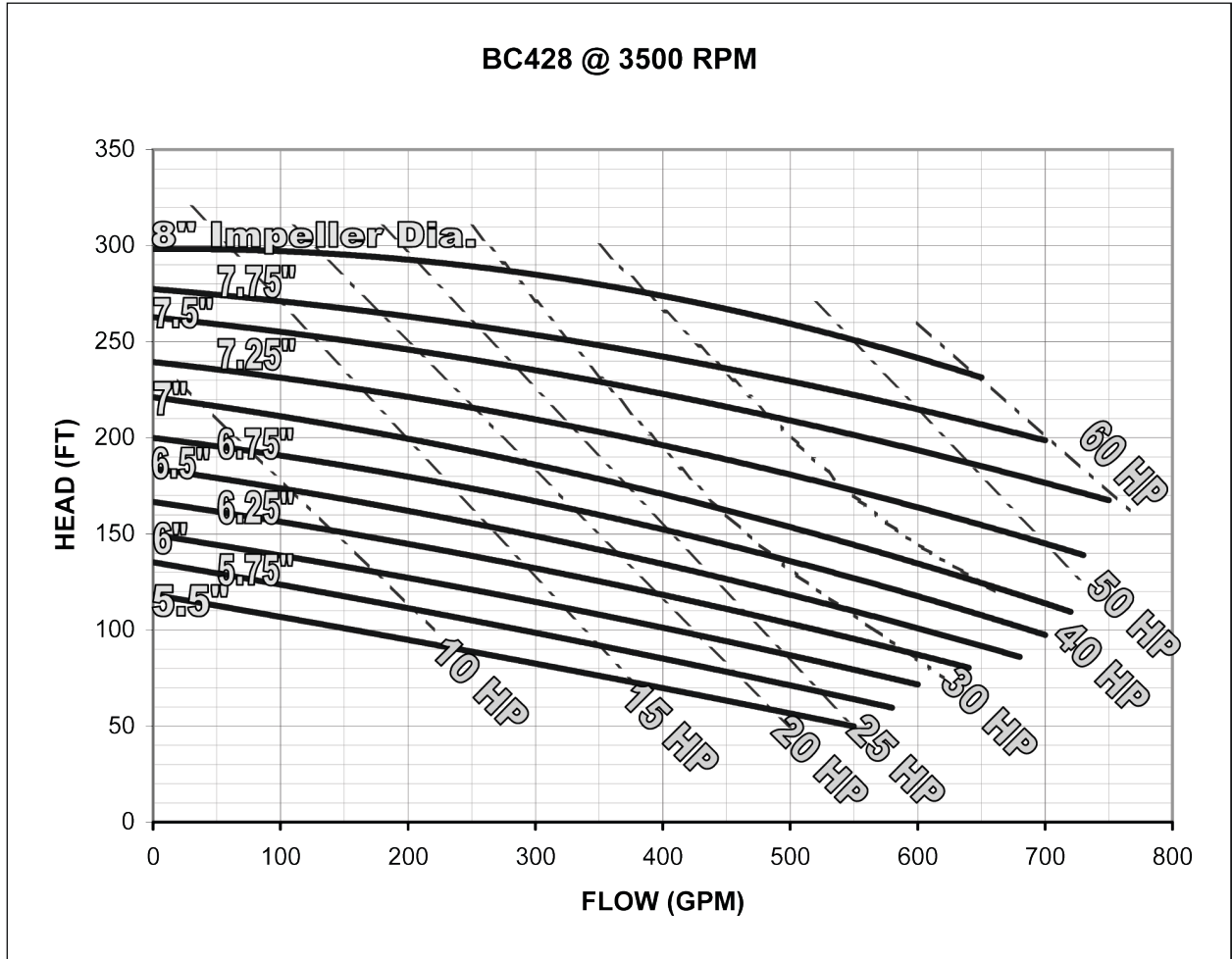

# BP-Series Sanitary Centrifugal Pump



The Right Connection®

Size:	4x4x10
RPM:	1750
Frequency:	60Hz
Model #:	BP441

## BP-Series Centrifugal Pump

PERFORMANCE CURVES

(Based on H<sub>2</sub>O @ 70° F)

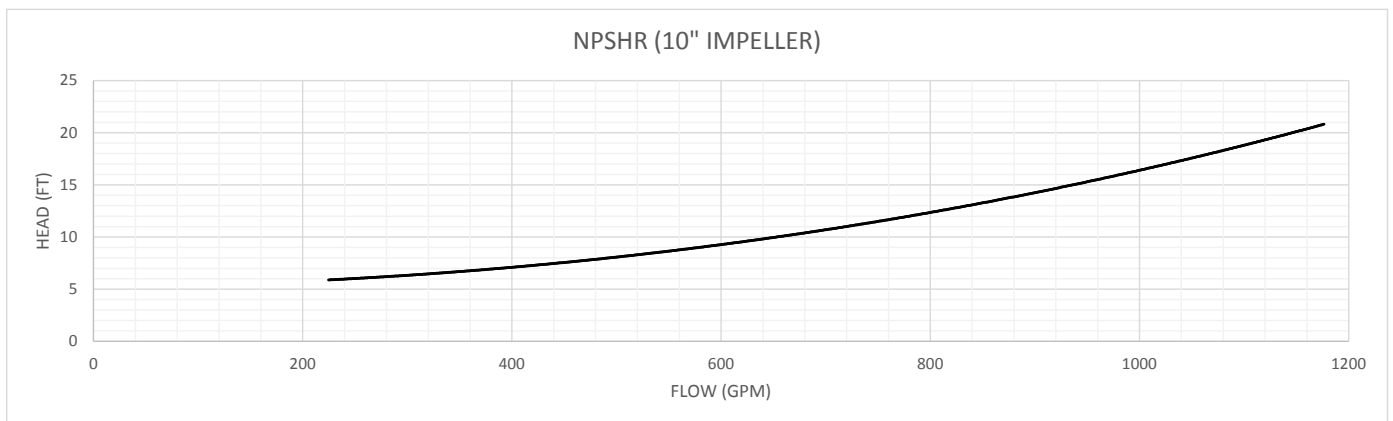
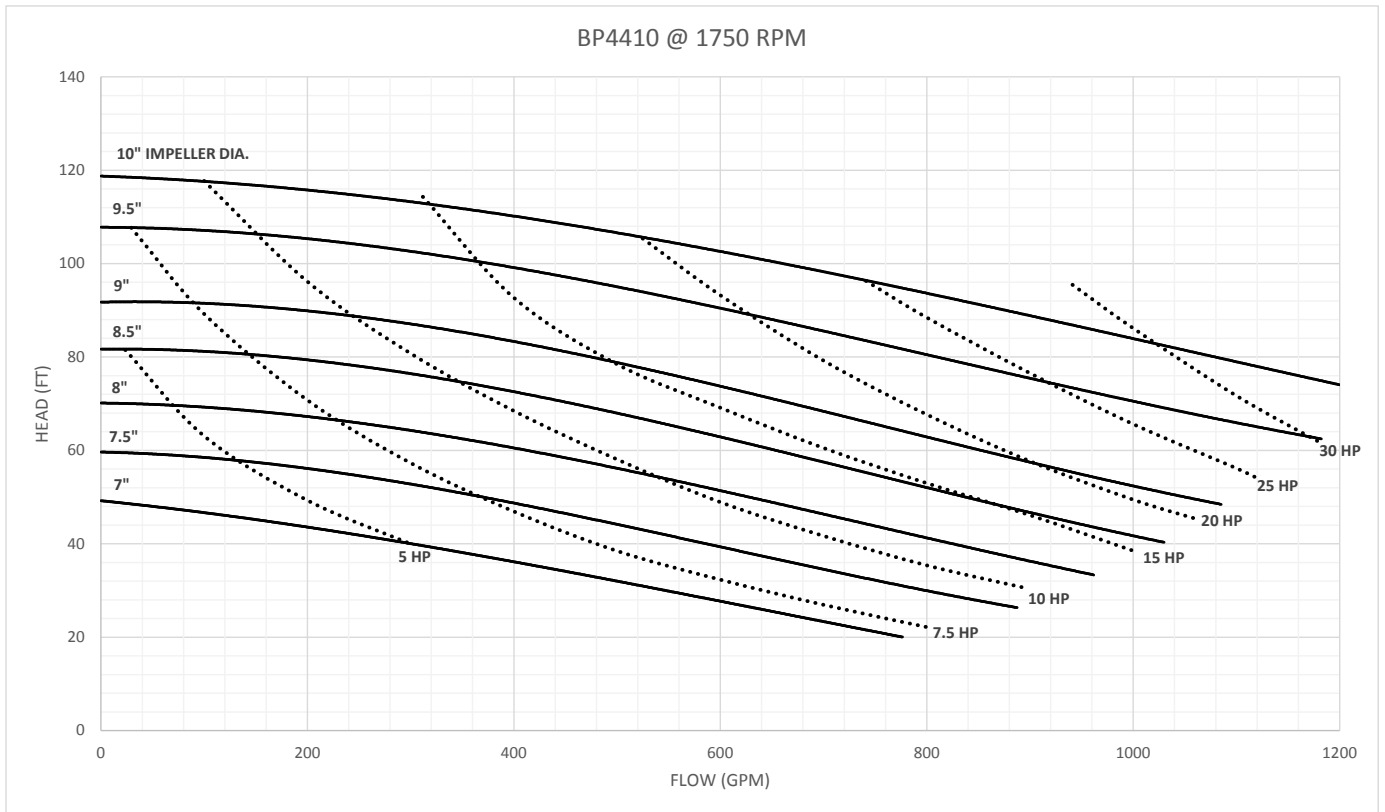

# BP-Series Sanitary Centrifugal Pump



The Right Connection®

Size:	4x4x10
RPM:	3500
Frequency:	60Hz
Model #:	BP441

## BP-Series Centrifugal Pump

PERFORMANCE CURVES

(Based on H<sub>2</sub>O @ 70° F)

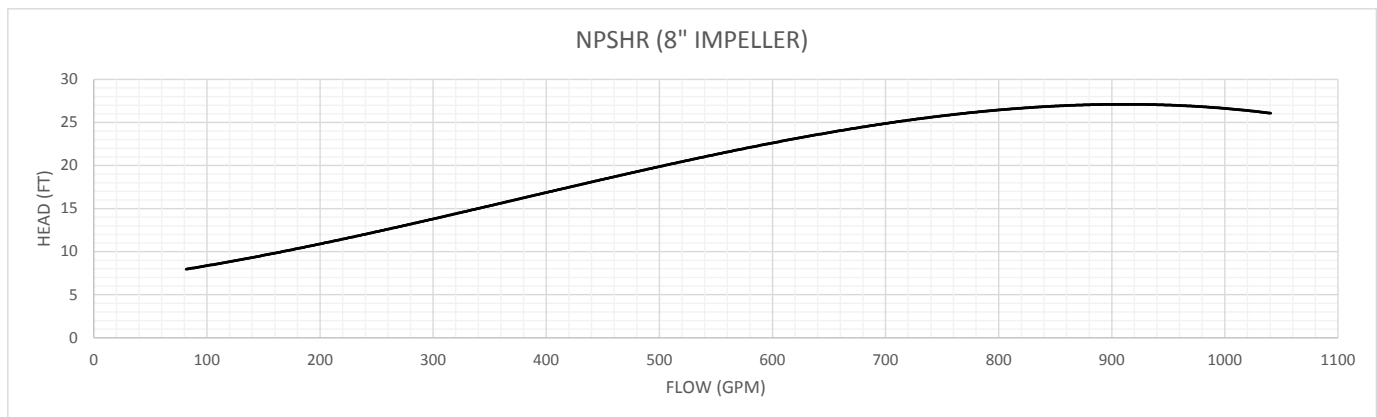
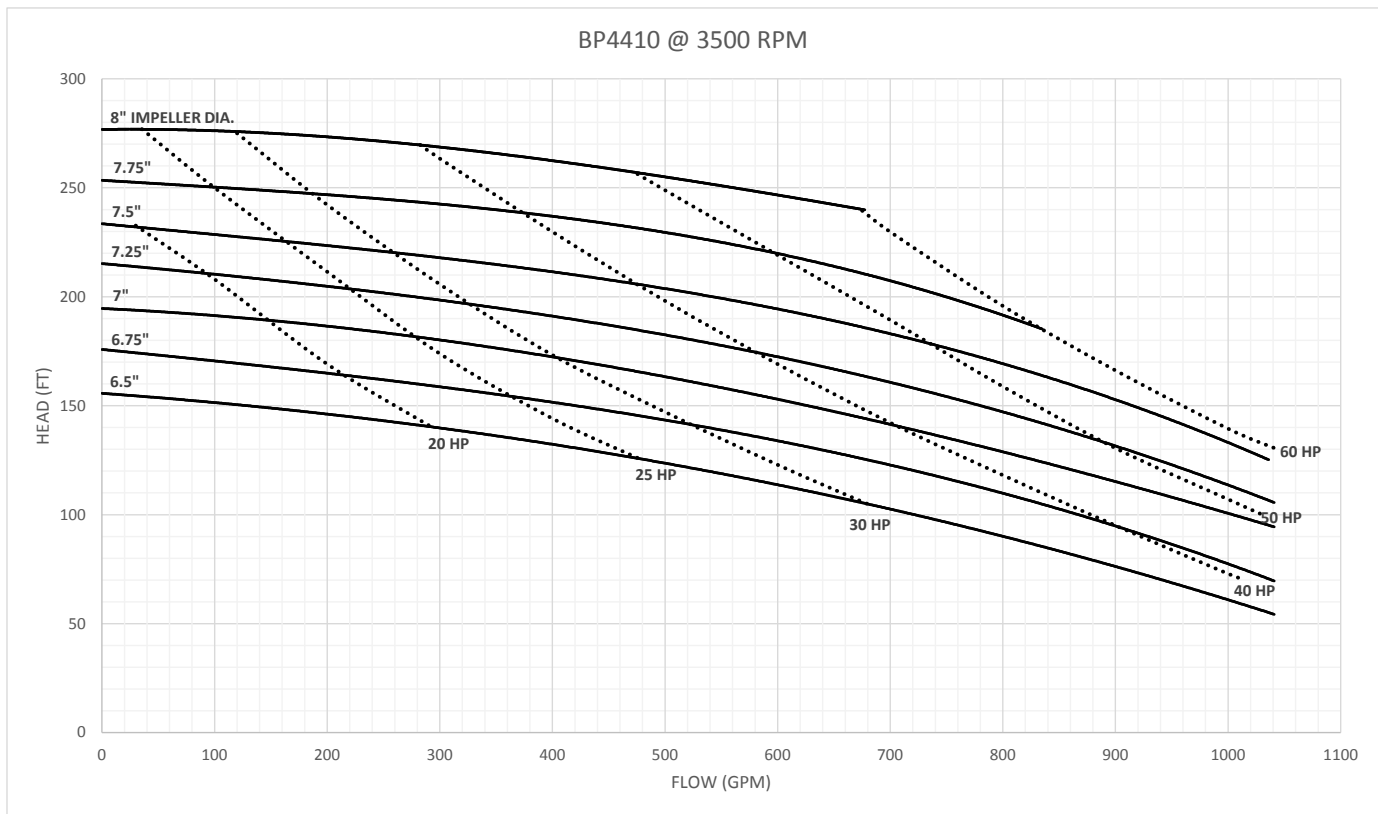



## BP-Series Sanitary Centrifugal Pump



The Right Connection®

Size:	6x4x10
RPM:	1750
Frequency:	60Hz
Model #:	BP641

### BP-Series Centrifugal Pump

PERFORMANCE CURVES

(Based on H<sub>2</sub>O @ 70° F)

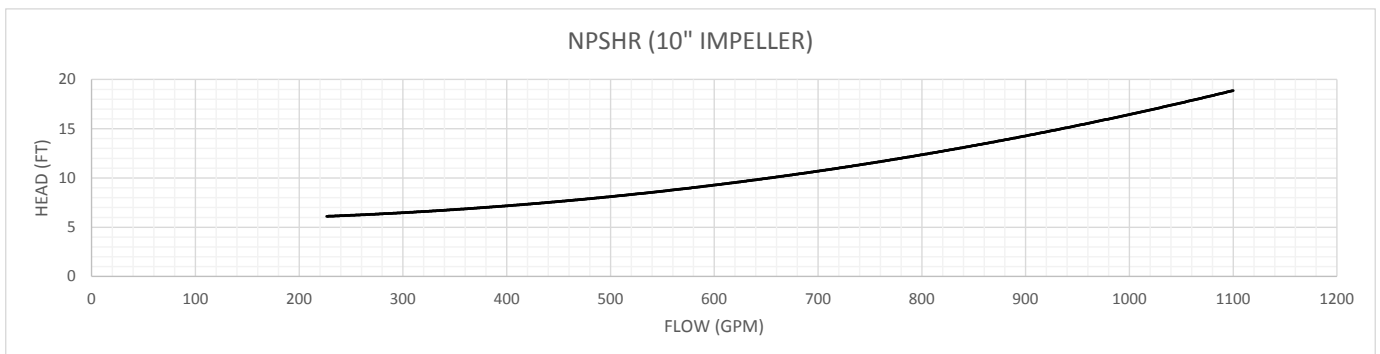
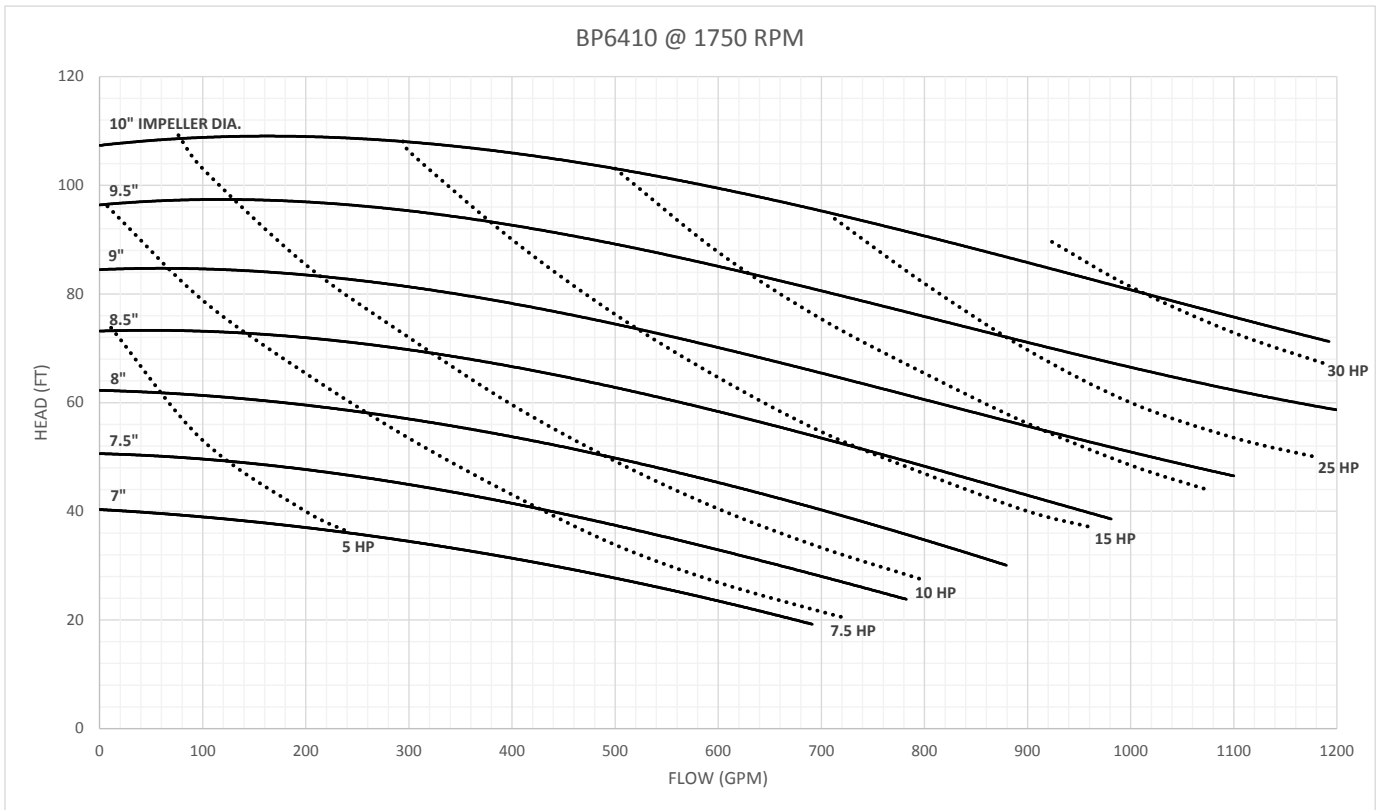

# BP-Series Sanitary Centrifugal Pump



The Right Connection®

Size:	6x4x10
RPM:	3500
Frequency:	60Hz
Model #:	BP641

## BP-Series Centrifugal Pump

PERFORMANCE CURVES

(Based on H<sub>2</sub>O @ 70° F)

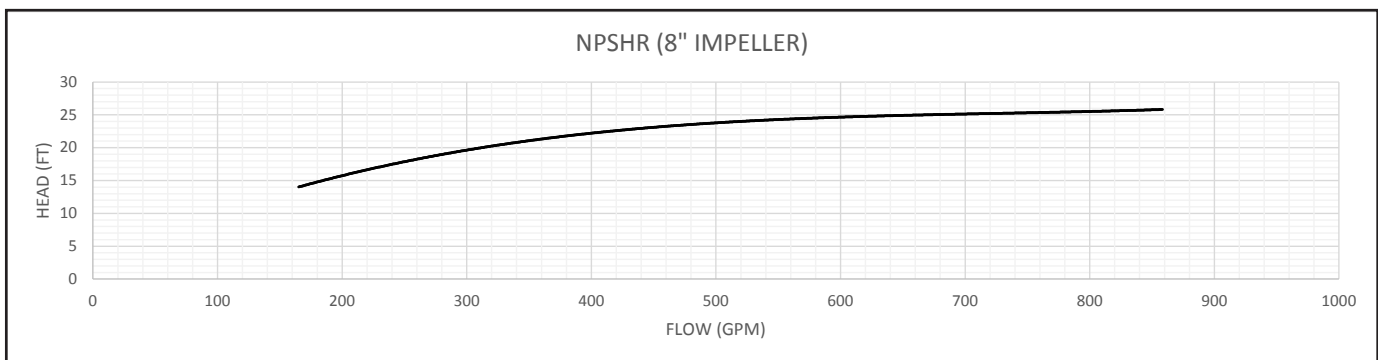
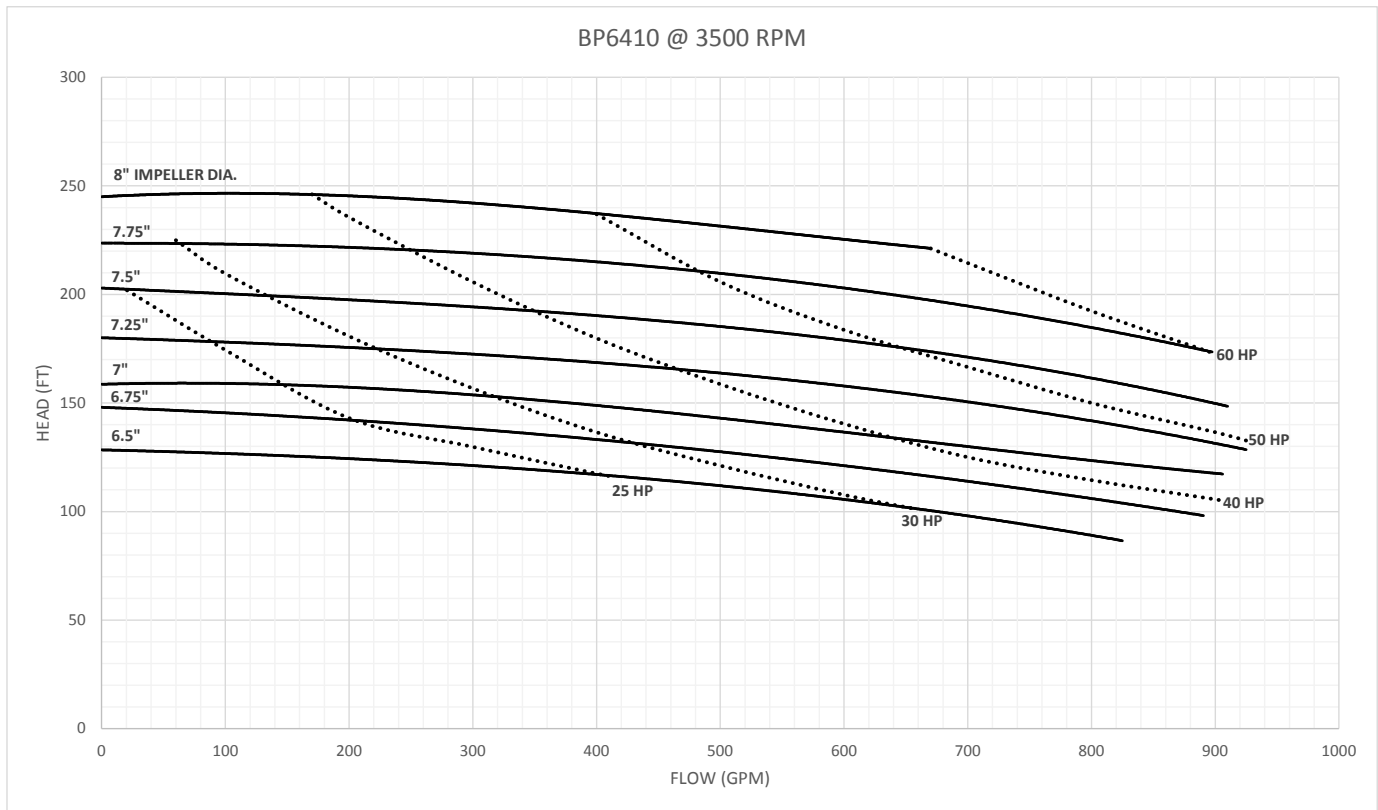

## Dimensions

All dimensions are given in inches

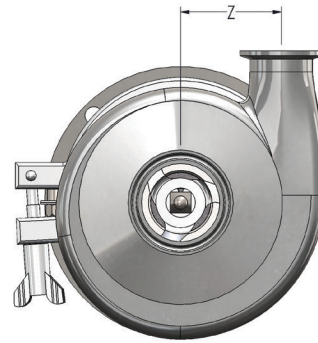
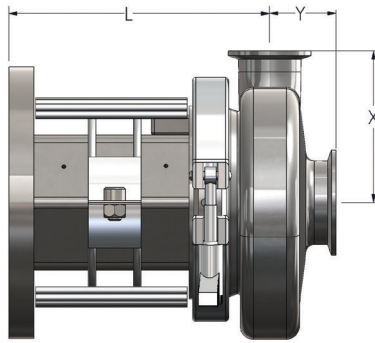

Pump Model	Inlet	Outlet	Z
BC114	1.5	1.5	2.63
BC214	2		
BC216	2	1.5	3.69
BC516	2.5		
BC218	2	1.5	4.75
BC318	3		
BC328	3	2	4.75
BC428	4		
BP441	4	4	7.60
BP641	6		

Pump Model	Frame Size	X	Y	L
BC114	56C	3.63	1.63	6.22
	140TC	3.63	1.63	6.22
	180TC	3.63	1.63	6.78
BC216	56C	4.50	1.94	6.06
	140TC	4.50	1.94	6.06
	180TC	4.50	1.94	6.69
	210TC	4.50	1.94	7.81
	250TC	4.50	1.94	8.50
BC218 & BC328	140TC	5.50	1.94 2.25 *	6.31
	180TC	5.50	1.94 2.25 *	6.94
	210TC	5.50	1.94 2.25 *	7.31
	250TC	5.50	1.94 2.25 *	8.19
	280TC	5.50	1.94 2.25 *	8.81
	320TC	5.50	1.94 2.25 *	9.69
BP441 & BP641	210TC	7.35	3.25 5.625**	10.53
	250TC	7.35	3.25 5.625**	10.53
	280TC	7.35	3.25 5.625**	11.16
	320TC	7.35	3.25 5.625**	10.53

## Dimensions

All dimensions are given in inches

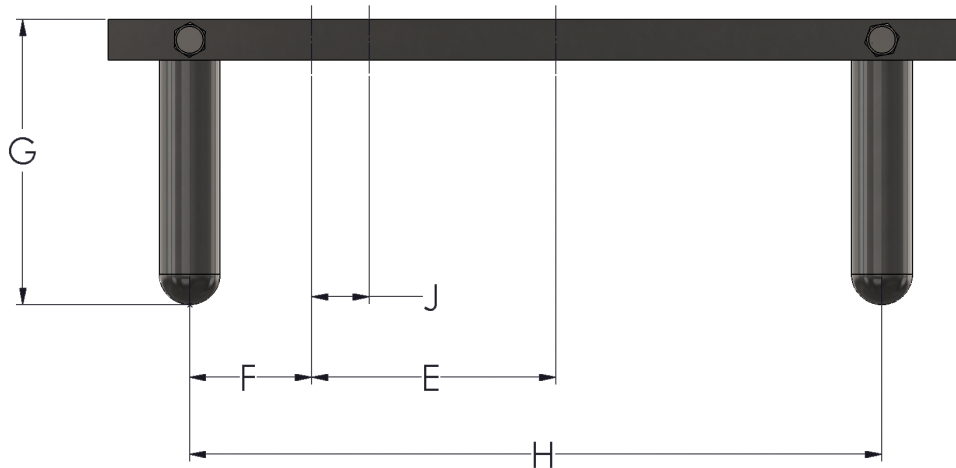

Frame Size	E	F	G	H	J
56C	3.00	1.50	3.50	8.50	NA
140TC	5.00	1.50	3.50	9.50	1.00
180TC	5.50	1.50	3.50	10.63	1.00
210TC	7.00	1.50	3.50	13.88	1.50
250TC	10.00	1.50	3.50	18.00	1.75
280TSC	11.00	1.50	3.50	19.00	1.50
320TSC	12.00	1.50	3.50	20.50	1.50

All dimensions are approximate;  
for exact dimensions contact Dixon Sanitary

## Troubleshooting

Dixon Sanitary BC-Series pumps are manufactured and inspected to meet sanitary standards. Occasional problems may arise. The following guide will help determine the possible cause and offer suggestions on corrections to maximize the performance of your pump. In case of any electric motors issues, contact the motor manufacturer directly. If you have any questions or concerns in regards to your BC-Series pump, we encourage you to contact Dixon Sanitary.

Problem	Possible Cause	Suggested Action
Not enough or no discharge	No fluid reaching pump.	Need to prime pump. Installation of a priming system is recommended.
	Suction or discharge closed or blocked.	Open suction. If plugged, shutdown pump and remove blockage. If closed, check all valves for proper positions.
	Motor rotation incorrect.	Adjust motor electrical wiring to correct rotation.
	Speed too slow (low voltage, wrong frequency, wrong motor).	Adjust voltage and frequency. Change motor if necessary.
	Impeller damaged.	Replace impeller.
	Seal area or supply area has an air leak.	Replace seal if needed. Check all other areas for air leaks and repair.
	Excessive air in material.	Make any adjustments in system to insure excess air is removed before material reaches the pump.
	Discharge head too high.	Adjust system to lower discharge head.
	Suction lift too high.	Adjust system to lower suction lift.
	Insufficient NPSH (Net Positive Suction Head) available.	Adjust system to provide correct NPSHa.
	Impeller diameter not correct for application.	Contact: Dixon Sanitary 800-789-1718
Not Enough Pressure	Seal area or supply area has an air leak.	Replace seal if needed. Check all other areas for air leaks and repair.
	Motor rotation incorrect.	Adjust motor electrical wiring to correct rotation.
	Speed too slow (low voltage, wrong frequency, wrong motor).	Adjust voltage and frequency. Change motor if necessary.
	Excessive air in material.	Make any adjustments in system to insure excess air is removed before material reaches the pump.
	Impeller diameter not correct for application.	Contact: Dixon Sanitary 800-789-1718
Motor Overload/Excessive Power Consumption	Discharge is too high.	Restrict discharge to lower flow rate.
	Impeller is binding.	Inspect pump and check for any damage, misalignment or interference. Replace any damaged or worn parts.
	Seal binding.	Inspect pump and replace any damaged or worn parts.
	Discharge is too low.	Increase discharge head.
	Liquid is heavier or more viscous than rating.	Contact: Dixon Sanitary 800-789-1718
	Electrical supply, voltage or frequency incorrect.	Make any adjustments needed up to replacing the motor.
	Faulty electrical connections.	Check wiring and repair/replace as necessary.
	Overload heaters too small.	Inspect and replace as necessary.
	Defective motor.	Contact motor manufacturer for possible warranty or repair. Replace if needed.

## Troubleshooting

Excessive Vibration/Pump is Noisy	Pump not level.	Inspect installation of pump and correct level.
	Non-supported piping.	Verify piping support follows recommendations in installation portion of this manual.
	Not enough or no material reaching pump.	Inspect pump to verify there is no blockage. Inspect suction line and shorten or enlarge.
	Insufficient NPSH (Net Positive Suction Head) available.	Adjust system to provide correct NPSHa.
	Impeller and/or shaft worn.	Replace worn parts.
	Shaft loose or bent.	Readjust shaft settings, tighten shaft screws if loose. If bent, replace shaft and inspect impeller hub for uneven wear, replace impeller if worn.
	Impeller out of balance.	Inspect shaft if loose or bent. If impeller damaged, replace.
	Foreign material in pump.	Remove any foreign material and replace any worn or damaged parts.
	Excessive air in material.	Make any adjustments in system to insure excess air is removed before material reaches the pump.
Rapid Seal Wear	Motor bearings worn.	Replace any worn parts or replace motor if needed.
	Improper installation of mechanical seal.	Adjust mechanical seal installation. Replace any worn or damaged parts.
	Dry running.	Material must be in contact with seal at all times. Catastrophic failure will occur.
	Abrasive product.	Contact: Dixon Sanitary 800-789-1718
	Shaft loose or bent.	Readjust shaft settings, tighten shaft screws if loose. If bent, replace shaft and inspect impeller hub for uneven wear, replace impeller if worn.
	Water hammer.	Correct system to prevent any quick starts and stops.
Pump Leaks	Improper seal for application.	Contact: Dixon Sanitary 800-789-1718
	Inlet/Outlet	Inspect for missing union gaskets, loose connections or damaged ports. Replace worn gaskets and tighten loose connections. Damaged ports repair or replace.
	Casing clamp loose.	Tighten clamp.
	Casing gasket damaged or worn.	Replace gaskets.
	Seal not installed correctly.	Reassemble seal properly. Replace any worn or damaged parts.
	Carbon seal worn or damaged.	Replace any worn or damaged parts.
Any Other Issue	'D' seal back plate worn.	Resurface or replace. "DG" option should be considered.
		Contact: Dixon Sanitary 800-789-1718

# Friction Loss Chart

## Friction Loss in Sanitary Tube and Fittings

*This table indicates loss of head due to friction in feet loss per foot of tubing or in feet loss per fitting.*

Capacity in US GPM	OD Tube Size																	
	1" I.D. = 0.870"			1½" I.D. = 1.370"			2" I.D. = 1.870"			2½" I.D. = 2.370"			3" I.D. = 2.870"			4" I.D. = 3.834"		
	Tubing	Elbow	Tee	Tubing	Elbow	Tee	Tubing	Elbow	Tee	Tubing	Elbow	Tee	Tubing	Elbow	Tee	Tubing	Elbow	Tee
5	.035	.025	.25															
10	.12	.06	.40	.02	.01	.15	.005	.015	.10									
15	.25	.10	.80	.04	.02	.25	.013	.02	.15									
20	.43	.22	1.5	.06	.03	.30	.02	.025	.20	.005	.02	.10	.003	.02	.06			
25	.66	.40	2.3	.08	.04	.40	.025	.03	.25	.006	.03	.15	.004	.03	.08			
30	.93	.70	3.3	.105	.06	.55	.035	.05	.30	.008	.05	.20	.005	.04	.10			
35	1.22	1.25	5.2	.135	.09	.80	.04	.06	.40	.011	.06	.25	.006	.05	.13			
40				.17	.11	1.0	.05	.08	.50	.015	.07	.30	.007	.06	.15			
45				.21	.16	1.3	.063	.10	.60	.02	.09	.35	.008	.065	.18			
50				.25	.20	1.6	.073	.12	.70	.022	.10	.40	.01	.07	.20			
60				.34	.35	2.2	.10	.18	.90	.03	.12	.45	.015	.08	.25			
80				.57	.76	3.7	.16	.30	1.5	.05	.15	.55	.02	.10	.40			
100				.85	1.35	5.8	.23	.44	2.3	.075	.18	.60	.03	.11	.50	.008	.04	.10
120				1.18	2.05	9.1	.32	.64	3.3	.105	.21	1.0	.04	.13	.60	.01	.05	.15
140							.42	.85	4.5	.14	.23	1.25	.05	.16	.80	.013	.06	.2
160							.54	1.13	5.8	.17	.28	1.6	.07	.20	1.1	.015	.07	.25
180							.67	1.45	7.4	.205	.31	2.0	.08	.21	1.3	.02	.08	.30
200							.81	1.82	9.0	.245	.35	2.5	.10	.26	1.6	.025	.09	.40
220							.95	2.22	11.0	.29	.41	3.0	.12	.30	1.9	.028	.10	.50
240							1.10	2.63	13.5	.34	.48	3.7	.14	.33	2.2	.035	.11	.55
260										.39	.53	4.5	.165	.39	2.5	.04	.115	.60
280										.45	.61	5.3	.19	.42	2.8	.045	.12	.65
300										.515	.70	6.2	.22	.50	3.1	.05	.13	.70
350										.68	1.05	8.5	.28	.67	4.1	.07	.15	.90
400										.86	1.55	11.0	.38	.88	5.2	.085	.18	1.2
450										1.05	2.25	13.5	.44	1.1	6.6	.105	.20	1.5
500													.54	1.4	8.0	.13	.23	1.75
550													.64	1.7	9.5	.15	.27	2.1
600													.75	2.05	10.2	.175	.30	2.5
650													.87	2.41	13.0	.20	.34	2.8
700													1.0	2.8	15.0	.23	.40	3.4
750																.26	.43	3.8
800																.30	.50	4.4

## CIP Flow Rate

### CIP Flow Rate Requirements 5 Feet Per Second Sanitary Tubing

Size	Flow
1"	10 GPM
1 1/2"	24 GPM
2"	43 GPM
2 1/2"	69 GPM
3"	101 GPM
4"	180 GPM

## Water Vapor Pressure Chart

### TEMPERATURE - VAPOR PRESSURE FOR WATER

At sea level the saturation pressure of vapor pressure (PSIG) = vapor pressure (PSIA - 14.7).

Temperature °F	Vapor Pressure PSIA	Temperature °F	Vapor Pressure PSIA	Temperature °F	Vapor Pressure PSIA	Temperature °F	Vapor Pressure PSIA
32	0.088	190	9.339	320	89.66	460	466.9
35	0.100	195	10.385	324	94.84	465	490.3
40	0.122	200	11.526	328	100.3	470	514.7
45	0.148	204	12.512	332	105.9	475	539.9
50	0.178	208	13.568	336	111.8	480	566.1
55	0.214	212	14.70	340	118.0	485	593.3
60	0.256	216	15.90	344	124.4	490	621.4
65	0.306	220	17.19	348	131.2	495	650.6
70	0.363	224	18.56	352	138.2	500	680.8
75	0.430	228	20.03	356	145.4	505	712.0
80	0.507	232	21.58	360	153.0	510	744.3
85	0.596	236	23.22	364	160.9	515	777.8
90	0.698	240	24.97	368	169.2	520	812.4
95	0.815	244	26.83	372	177.7	525	848.1
100	0.949	248	28.80	376	186.6	530	885.0
105	1.102	252	30.88	380	195.8	535	923.2
110	1.275	256	33.09	384	205.3	540	962.5
115	1.471	260	35.43	388	215.3	545	1003
120	1.692	264	37.90	392	225.6	550	1045
125	1.942	268	40.50	396	236.2	555	1088
130	2.222	272	43.25	400	247.3	560	1133
135	2.537	276	46.15	405	261.7	565	1179
140	2.889	280	49.20	410	276.8	570	1226
145	3.281	284	52.42	415	292.4	575	1275
150	3.718	288	55.80	420	308.8	580	1326
155	4.203	292	59.36	425	325.9	585	1378
160	4.741	296	63.09	430	343.7	590	1431
165	5.335	300	67.01	435	362.3	595	1486
170	5.992	304	71.13	440	381.6	600	1543
175	6.715	308	75.44	445	401.7		
180	7.510	312	79.96	450	422.6		
185	8.383	316	84.70	455	444.3		



## Centrifugal Pump Characteristics

The Dixon BC-Series centrifugal pump is characterized as a radial flow centrifugal pump. Radial flow pumps operate according to a specific set of laws known as the Affinity Laws. These laws demonstrate the mathematical relationship between impeller diameter, flow, pressure, brake horsepower, and motor speed. Each of these characteristics and the equations that govern them will be given in detail below. It is important to understand that when dealing with variant centrifugal pumps such as axial or mixed flow, other variables must be taken into consideration. The following equations are only intended for radial flow centrifugal pump applications.

### Variance in impeller diameter while maintaining constant motor speed

$$\frac{D_1}{D_2} = \frac{Q_1}{Q_2} = \frac{\sqrt{H_1}}{\sqrt{H_2}}$$

$$\frac{BHP_1}{BHP_2} = \frac{D_1^3}{D_2^3}$$

Where: D= Impeller diameter (in)  
 Q= Flow rate (gpm)  
 H= Head pressure (ft)  
 BHP= Brake horsepower (hp)

### Variance in motor speed with constant impeller diameter

$$\frac{S_1}{S_2} = \frac{Q_1}{Q_2} = \frac{\sqrt{H_1}}{\sqrt{H_2}}$$

$$\frac{BHP_1}{BHP_2} = \frac{S_1^3}{S_2^3}$$

Where: S= Motor speed (rpm)  
 Q= Flow rate (gpm)  
 H= Head pressure (ft)  
 BHP= Brake horsepower (hp)

## Viscosity Chart

N - Newtonian  
 T - Thixotropic  
 D - Dilatent

	Fluid	Specific Gravity	Viscosity CPS	Viscous Type
<b>Reference</b>	Water	1.0	1.0	N
<b>Adhesives</b>	"Box" Adhesives	1+-	3,000	T
	PVA	1.3	100	T
	Rubber & Solvents	1.0	15,000	N
<b>Bakery</b>	Batter	1.0	2,000	T
	Butter (Melted)	0.98	18 @ 140°F	N
	Egg (Whole)	0.5	60 @ 50°F	N
	Emulsifier		20	T
	Frosting	1.0	10,000	T
	Lectithin		3,250 @ 125°F	T
	77% Sweetened Condensed Milk	1.3	10,000 @ 77°F	N
	Yeast Slurry 15%	1.0	180	T
<b>Beer/Wine</b>	Beer	1.0	1.1 @ 40°F	N
	Brewers Concentrated Yeast (80% solids)		16,000 @ 40°F	T
	Wort			
	Wine	1		
<b>Confectionery</b>	Caramel	1.2	400 @ 140°F	
	Chocolate	1.1	17,000 @ 120°F	T
	Fudge (Hot)	1.1	36,000	T
	Toffee	1.2	87,000	T
<b>Cosmetics/Soaps</b>	Face Cream		10,000	T
	Hair Gel	1.4	5,000	T
	Shampoo		5,000	T
	Toothpaste		20,000	T
	Hand Cleaner		2,000	T
<b>Dairy</b>	Cottage Cheese	1.08	225	T
	Cream	1.02	20 @ 40°F	N
	Milk	1.03	1.2 @ 60°F	N
	Process Cheese		30,000 @ 160°F	T
	Yogurt		1,100	T
<b>Detergents</b>	Detergent Concentrate		10	N
<b>Dyes &amp; Inks</b>	Printers Ink	1 to 1.38	10,000	T
	Dye	1.1	10	N
	Gum		5,000	T
<b>Fats &amp; Oils</b>	Corn Oil	0.92	30	N
	Lard	0.96	60 @ 100°F	N
	Linseed Oil	0.93	30 @ 100°F	N
	Peanut Oil	0.92	42 @ 100°F	N
	Soybean Oil	0.95	36 @ 100°F	N
	Vegetable Oil	0.92	3 @ 300°F	N
<b>Misc. Foods</b>	Black Bean Paste		10,000	T
	Cream Style Corn		130 @ 190°F	T
	Catsup (Ketsup)	1.11	560 @ 145°F	T
	Pablum		4,500	T
	Pear Pulp		4,000 @ 160°F	T
	Mashed Potato	1	20,000	T
	Potato Skins & Caustic		20,000 @ 100°F	T
	Prune Juice	1	60 @ 120°F	T
	Orange Juice Concentrate	1.1	5,000 @ 38°F	T
	Tapioca Pudding	0.7	1,000 @ 235°F	T
	Mayonnaise	1	5,000 @ 75°F	T
	33% Tomato Paste	1.14	7,000	T
	Honey	1.5	1,500 @ 100°F	

## Viscosity Chart

N - Newtonian  
T - Thixotropic  
D - Dilatent

	Fluid	Specific Gravity	Viscosity CPS	Viscous Type
<b>Meat Products</b>	Melted Animal Fats	0.9	43 @ 100°F	N
	Ground Beef Fats	0.9	11,000 @ 60°F	T
	Meat Emulsion	1	22,000 @ 40°F	T
	Pet Food	1	11,000 @ 40°F	T
	Pork Fat Slurry	1	650 @ 40°F	T
<b>Misc. Chemicals</b>	Glycols	1.1	35 @ Range	
<b>Paint</b>	Metallic Auto Paints		220	T
	Solvents	0.8 to 0.9	0.5 to 10	N
	Titanium Dioxide Slurry		10,000	T
	Varnish	1.06	140 @ 100°F	
	Turpentine	0.86	2 @ 60°F	
<b>Paper &amp; Textile</b>	Black Liquor Tar		2,000 @ 300°F	
	Paper Coating 35%		400	
	Sulfide 6%		1,600	
	Black Liquor	1.3	1,100 @ 122°F	
	Black Liquor Soap		7,000 @ 122°F	
<b>Petroleum &amp; Petroleum Products</b>	Asphalt (Unblended)	1.3	500 to 2,500	
	Gasoline	0.7	0.8 @ 60°F	N
	Kerosene	0.8	3 @ 68°F	N
	Fuel Oil #6	0.9	660 @ 122°F	N
	Auto Lube Oil SAE 40	0.9	200 @ 100°F	N
	Auto Lube Oil SAE 90	0.9	320 @ 100°F	N
	Propane	0.46	0.2 @ 100°F	N
	Tars	1.2	Wide Range	
<b>Pharmaceuticals</b>	Castor Oil	0.96	350	N
	Cough Syrup	1	190	N
	"Stomach" Remedy Slurries		1,500	T
	Pill Pastes		5,000 +/-	T
<b>Plastic Resins</b>	Butadiene	0.94	0.17 @ 40°F	
	Polyester Resin (Typ)	1.4	3,000	T
	PVA Resin (Typ)	1.3	65,000	
	(Wide variety of plastics can be pumped, viscosity varies greatly)			
<b>Starches &amp; Gums</b>	Corn Starch Sol 22°B	1.18	32	T
	Corn Starch Sol 25°B	1.21	300	T
<b>Sugar, Syrups, Molasses</b>	Corn Syrup 41 Be	1.39	15,000 @ 60°F	N
	Corn Syrup 45 Be	1.45	12,000 @ 130°F	N
	Glucose	1.42	10,000 @ 100°F	
	Molasses A	1.42	280 to 5,000 @ 100°F	
	B	1.43 to 1.48	1,400 to 13,000 @ 100°F	
	C	1.46 to 1.49	2,600 to 5,000 @ 100°F	
	Sugar Syrups			
	60 Brix	1.29	75 @ 60°F	N
	68 Brix	1.34	360 @ 60°F	N
76 Brix	1.39	4,000 @ 60°F	N	
<b>Water &amp; Waste Treatment</b>	Clarified Sewage Sludge	1.1	2,000 Range	

# Model No.'s & Part No.'s

## Pump Models

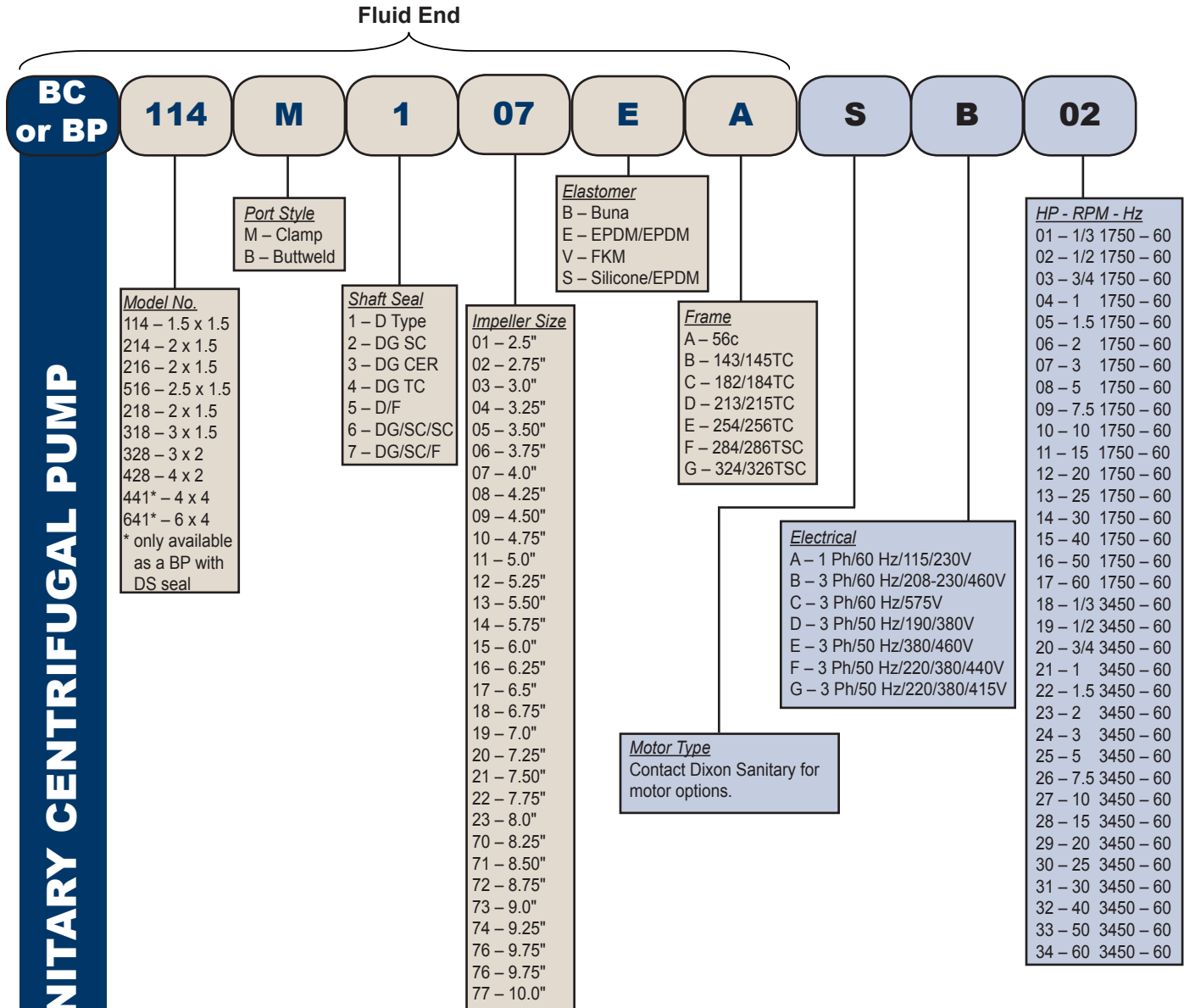

**DIXON SANITARY CENTRIFUGAL PUMP**

Fluid end includes all parts required to assemble to your motor.

Specify adjustable leg kits at time of order. Leg kits will be shipped to match the frame size of motor as specified by model number. Leg kits will not be assembled.

Please note, if there are options that are not listed above, please contact Dixon Sanitary (800.789.1718) for availability and pricing.

# Repair Kits

## BC & BP-Series Repair Kits

### Repair Kit # 1

BC	BP*
1 - Casing Gasket (P90)	1 - Casing Gasket (P90)
1 - Carbon Seal (P80)	1 - Carbon Seal (P80)
1 - Seal O-ring (P80B)	1 - Seal O-ring (P80B)
1 - Impeller Retainer (P24)	1 - Impeller Nut O-ring (P25B)
	1 - Impeller O-ring (P25A)*

\* For models 114, 216 and 218/328 needing a BP repair kit, please add BP to the end of the kit part number.

Model Number	Buna	EPDM	Silicone	FKM
BC114	PRK1-114B	PRK1-114E	PRK1-114S	PRK1-114V
BC216	PRK1-216B	PRK1-216E	PRK1-216S	PRK1-216V
BC218/BC328	PRK1-218BB	PRK1-218BE	PRK1-218BS	PRK1-218BV
BP441	PRK1-441B	PRK1-441E	N/A	PRK1-441V

\*BP441 only

### Repair Kit # 2

3 - Casing Gasket (P90)	3 - Seal O-Ring (P80B)	3 - Carbon Seal (P80)
-------------------------	------------------------	-----------------------

Model Number	Buna	EPDM	Silicone	FKM
BC114	PRK2-114B	PRK2-114E	PRK2-114S	PRK2-114V
BC216	PRK2-216B	PRK2-216E	PRK2-216S	PRK2-216V
BC218/BC328	PRK2-218BB	PRK2-218BE	PRK2-218BS	PRK2-218BV
BP441	PRK2-441B	PRK2-441E	N/A	PRK2-441V

### Repair Kit # 3

1 - Carbon Seal (P80)	1 - Seal O-Ring (P80B)
1 - Spring (P80C)	1 - Cup (P80A)

Model Number	Buna	EPDM	Silicone	FKM
BC114	PRK3-114B	PRK3-114E	PRK3-114S	PRK3-114V
BC216	PRK3-216B	PRK3-216E	PRK3-216S	PRK3-216V
BC218/BC328	PRK3-218BB	PRK3-218BE	PRK3-218BS	PRK3-218BV
BP441	PRK3-114B	PRK3-441E	N/A	PRK3-441V

### Repair Kit # 4

BC	BP
1 - Casing Gasket (P90)	1 - Casing Gasket (P90)
1 - Carbon Seal (P80)	1 - Carbon Seal (P80)
1 - Seal O-ring (P80B)	1 - Seal O-ring (P80B)
1 - Impeller Retainer (P24)	1 - Impeller Nut O-ring (P25B)
1 - Seal Cup (P80A)	1 - Seal Cup (P80A)
1 - Spring (P80C)	1 - Spring (P80C)
	1 - Impeller O-ring (P25A)*

\* For models 114, 216 and 218/328 needing a BP repair kit, please add BP to the end of the kit part number.

Model Number	Buna	EPDM	Silicone	FKM
BC114	PRK4-114B	PRK4-114E	PRK4-114S	PRK4-114V
BC216	PRK4-216B	PRK4-216E	PRK4-216S	PRK4-216V
BC218/BC328	PRK4-218BB	PRK4-218BE	PRK4-218BS	PRK4-218BV
BP441	PRK4-441B	PRK4-441E	N/A	PRK4-441V

\*BP441 only

# Repair Kits

## BC & BP-Series DG Repair Kits

### DG Repair Kit

BC	BP
1 - Seal Seat (P80N)	1 - Seal Seat (P80N)
1 - Seal O-ring (P80B)	1 - Seal O-ring (P80B)
1 - Impeller Pin (P24)	1 - Impeller Nut O-ring (P25B)
1 - Carbon Seal (P80)	1 - Carbon Seal (P80)
1 - Spring (P80C)	1 - Spring (P80C)
1 - Inboard Gasket (P80R)	1 - Inboard Gasket (P80R)
1 - Seal Cup (P80A)	1 - Seal Cup (P80A)
1 - Casing Gasket (P90)	1 - Casing Gasket (P90)
1 - Outboard Gasket (P80P)	1 - Outboard Gasket (P80P)
	1 - Impeller O-ring (P25A)*

\* For models 114, 216 and 218/328 needing a BP repair kit, please add BP to the end of the kit part number.

Model Number	Elastomer	Ceramic	SC	TC
<b>BC114</b>	Buna	PRKDG-114BCER	PRKDG-114BSC	PRKDG-114BTC
	EPDM	PRKDG-114ECER	PRKDG-114ESC	PRKDG-114ETC
	SILICONE	PRKDG-114SCER	PRKDG-114SSC	PRKDG-114STC
	FKM	PRKDG-114VCER	PRKDG-114VSC	PRKDG-114VTC
<b>BC216</b>	Buna	PRKDG-216BCER	PRKDG-216BSC	PRKDG-216BTC
	EPDM	PRKDG-216ECER	PRKDG-216ESC	PRKDG-216ETC
	SILICONE	PRKDG-216SCER	PRKDG-216SSC	PRKDG-216STC
	FKM	PRKDG-216VCER	PRKDG-216VSC	PRKDG-216VTC
<b>BC218/BC328</b>	Buna	PRKDG-218BBCER	PRKDG-218BBSC	PRKDG-218BBTC
	EPDM	PRKDG-218BECER	PRKDG-218BESC	PRKDG-218BETC
	SILICONE	PRKDG-218BSCER	PRKDG-218BSSC	PRKDG-218BSTC
	FKM	PRKDG-218BVCER	PRKDG-218BVSC	PRKDG-218BVTC
<b>BP441</b>	Buna	PRKDG-441BCER	PRKDG-441BSC	PRKDG-441BTC
	EPDM	PRKDG-441ECER	PRKDG-441ESC	PRKDG-441ETC
	FKM	PRKDG-441VCER	PRKDG-441VSC	PRKDG-441VTC

\*BP441 only

### DG Conversion Kit

1 - DG Backplate (P11H)	1 - Gland Ring (P17J)	4 - Gland Bolts (P17K)
4 - Lock Washers (P17M)	1 - Seal Seat (P80N)	1 - Outboard Gasket (P80P)
1 - Inboard Gasket (P80R)		

Model Number	Ceramic	SC	TC
<b>BC114</b>	PCK-114DGCER	PCK-114DGSC	PCK-114DGTC
<b>BC216</b>	PCK-216DGCER	PCK-216DGSC	PCK-216DGTC
<b>BC218/BC328</b>	PCK-218BDGCER	PCK-218BDGSC	PCK-218BDGTC

# Key Numbers

## Part Number Breakdown

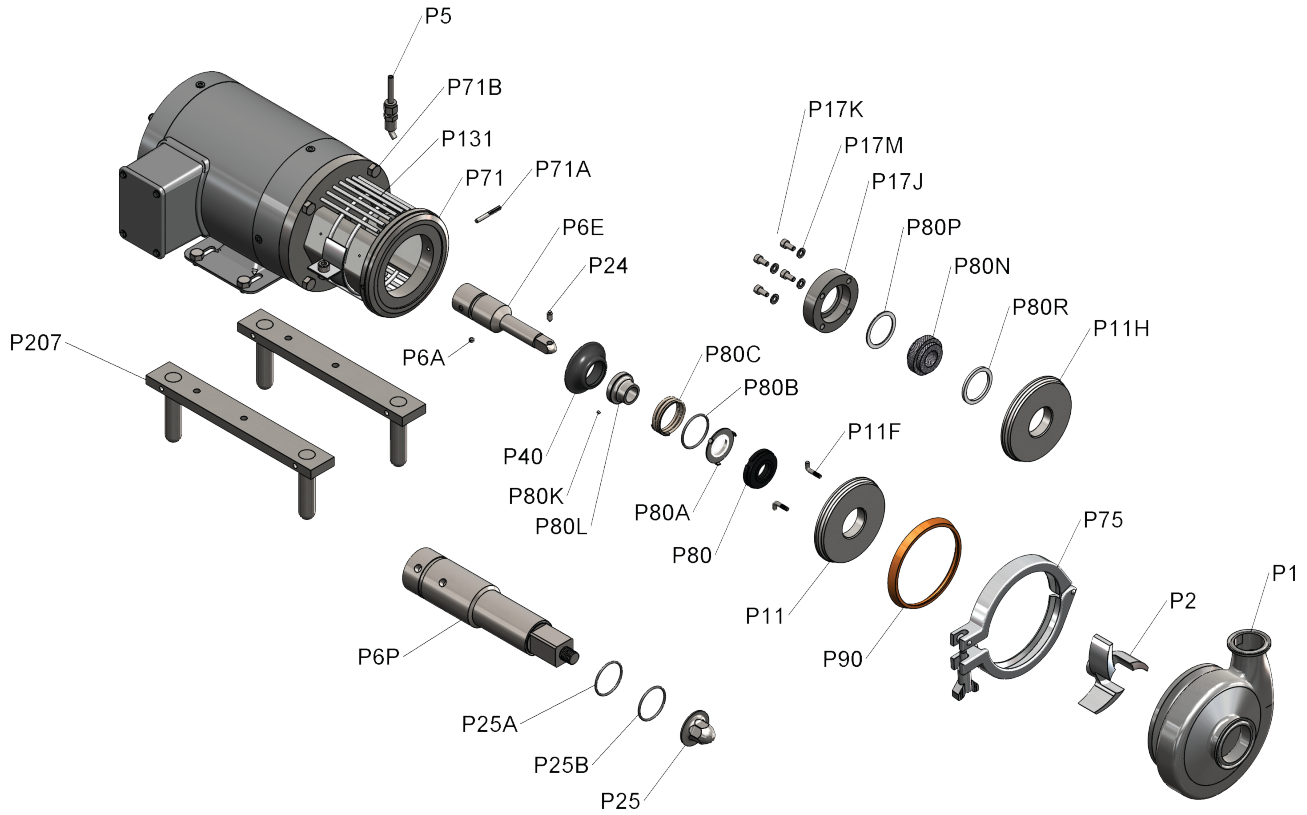

Key No.	Description
P1	Casing
P2	Impeller
P6A	Shaft Set Screws
P6E	Stub Shaft
P11	'D' Back Plate
P11F	Back Plate Pins*
P24	Impeller Retainer
P40	Deflector
P71	Adapter
P71A	Adapter Pins*
P75	Clamp Assembly
P80	Carbon Seal
P80A	Seal Cup
P80B	Seal O'Ring
P80C	Spring
P80K	Seat Screw
P80L	Drive Collar
P90	Casing Gasket
P131	Guard Assembly
P207	Leg Kit

### DG Seal

Key No.	Description
P11H	'DG' Back Plate
P17J	Gland Ring
P17K	Gland Bolt
P17M	Washers
P80N	Seal Seat
P80P	Outboard Gasket
P80R	Inboard Gasket

### F Seal

Key No.	Description
P5	F Seal Fitting

### BP Threaded Impeller Nut

Key No.	Description
P6P	Stub Shaft
P25	Impeller Nut
P25A	Impeller O-ring
P25B	Impeller Nut O-ring

\*not used on BC114/214 DG Models

## Sanitary Centrifugal Pump Casing Drain Options

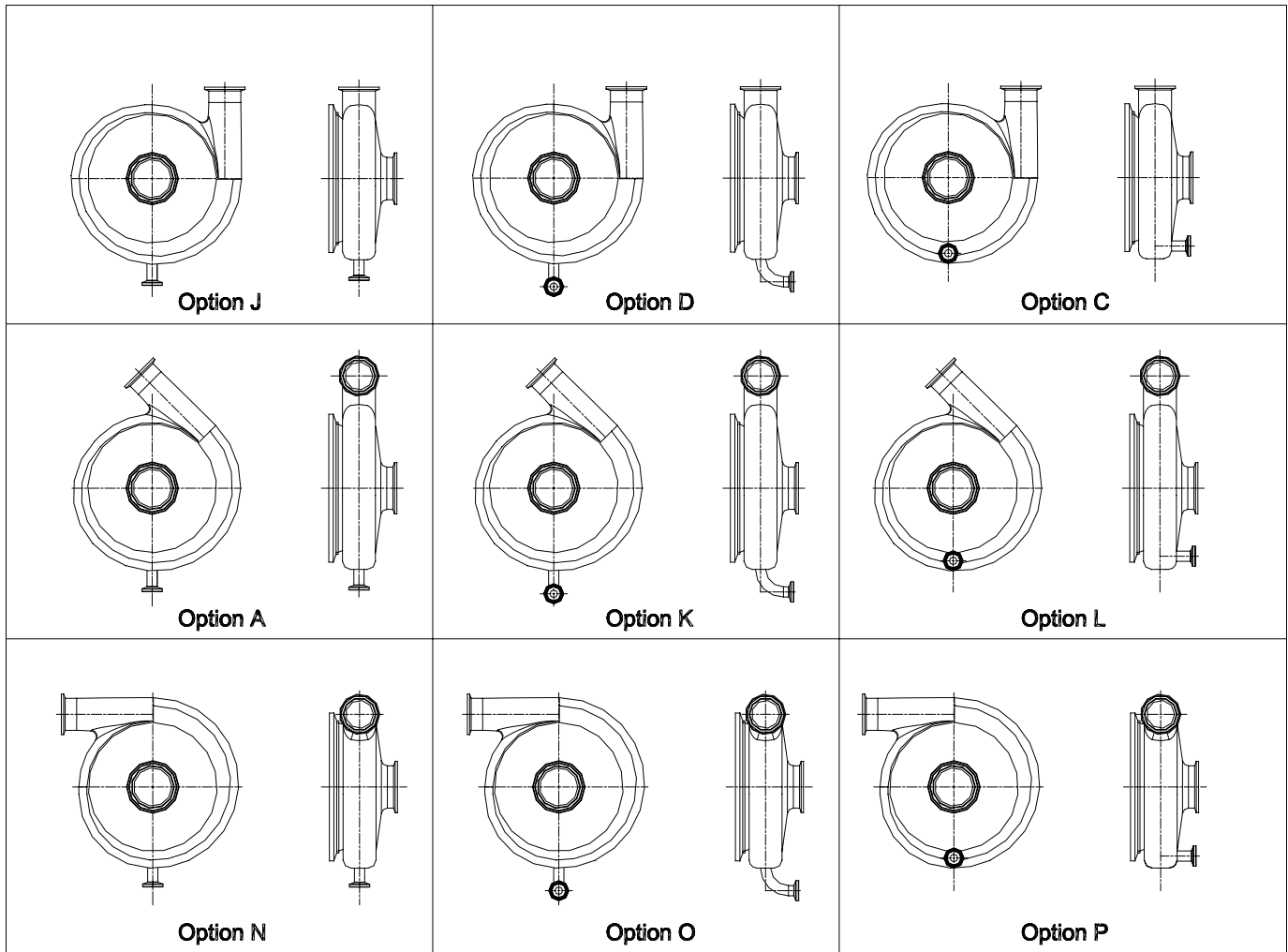

Contact Dixon Sanitary Engineering Department for other configurations.





Contact Name: \_\_\_\_\_ Company Name: \_\_\_\_\_

Project Name: \_\_\_\_\_

## Pump Check List

Contact Name: \_\_\_\_\_ Company Name: \_\_\_\_\_

Date: \_\_\_\_\_ Phone: \_\_\_\_\_ Email: \_\_\_\_\_

Customer ID: \_\_\_\_\_

### Application Data

Fluid: \_\_\_\_\_ Flow (GPM): \_\_\_\_\_

Fluid Temp: \_\_\_\_\_ Total Dynamic Head: \_\_\_\_\_ or PSI: \_\_\_\_\_

Viscosity (CPS): \_\_\_\_\_ Specific Gravity: \_\_\_\_\_

NPSH Available: \_\_\_\_\_

### Preferred Connection Size (Inlet x Outlet)

BC114 (1½" x 1½") <input type="checkbox"/>	BC214 (2" x 1½") <input type="checkbox"/>	BC216 (2" x 1½") <input type="checkbox"/>
BC218 (2" x 1½") <input type="checkbox"/>	BC318 (3" x 1½") <input type="checkbox"/>	BC328 (3" x 2") <input type="checkbox"/>
BC516 (2½" x 1½") <input type="checkbox"/>		BC441 (4" x 4") <input type="checkbox"/>
BC428 (4" x 2") <input type="checkbox"/>		BC641 (6" x 4") <input type="checkbox"/>

### Connections

Clamp       Combination: \_\_\_\_\_ Inlet: \_\_\_\_\_ Outlet: \_\_\_\_\_

Weld       Other: \_\_\_\_\_

### Process Piping Information

Size / Qty of Elbows	/	Vertical pipe (size/length)		List check valves (size/type)	
Size / Qty of Tees	/	Horizontal pipe (size/length)			
BFVs Size / Qty	/	(For best sizing please include a piping diagram)			

### Seal Type

D- Seal       DG-Seal (CER)       Add flush (F-Seal)

DG-Seal (SC)       DG-Seal (TC)       Other: \_\_\_\_\_

### BC or BP Style

BC Impeller Retainer\*       \* Not available in 441 or 641 models

BP Threaded Impeller Nut

### Elastomer

Buna       EPDM       Silicone       FKM

### Motor Options

Enclosure	Voltage		Phase		Motor Options
Stainless Steel Washdown	115/230V	380/460V	Single Phase 50Hz		Variable Frequency Drive: (control/other info) <input type="checkbox"/>
Explosion Proof	208-230/460V	220/380/440V	Three Phase 50Hz		
Epoxy Painted Washdown	575V	220/380/415V	Single Phase 60Hz		
Totally Enclosed None Vented	190/380V		Three Phase 60Hz		

### Pump Options

Volute with drain (please specify location of drain and orientation)

Small Cart       Large Cart

Cart Options: \_\_\_\_\_

### Other Special Requests

(For all replacement pump orders please include all known information about pump being replaced.)

## Glossary

**3A** Symbol for 3A Sanitary Standards Symbol Administrative Council. The 3A Sanitary Standard were created by the dairy industry as a voluntary benchmark for product performance and sanitary safety. The standard, collaboratively developed by a group of processors, suppliers, regulatory officials and sanitation specialists, is accepted by federal, state and local regulatory authorities. Our products have earned the 3A symbol through third party verification. This assessment makes certain each product conforms in all respects to the published standards. Dixon Sanitary is proud to be a participant in the 3A program.

**3A Finish** Product surface finish equivalent to 150 grit or better OD, and 180 grit or better ID. A maximum of Ra 32 microinch (0.8 micron) is indicated.

**ABS** (Acrylonitrile-butadiene-styrene) a thermoplastic resin with an excellent resistance to acids, bases, salts and some solvents. It is heat resistant to 230°F.

**AC** Alternating current. The form in which electricity is delivered to businesses and residences.

**AFD** See *VFD*

**ANSI** American National Standards Institute, Inc.

**ASME** American Society of Mechanical Engineers

**ASTM** American Society for Testing and Materials

**Absolute Pressure** Atmospheric pressure added to gauge pressure.

**Acme Thread** A flat grooved helical ridge on a nut or bolt. This typically has a 29° included angle. Used on bevel seat and John Perry fittings

**Adapter** Connects the pump fluid end to the motor

**Affinity Laws** Used to predict how capacity, head and horsepower are affected by changes in the centrifugal pump impeller diameter or impeller speed.

**Ambient Temperature** The temperature at a point or area expressed as an average of the surrounding areas or materials. Ambient surface temperature is generally given to be 70°F to 80°F – an average of daily and seasonal variations.

**Anneal** Stress relief of stainless steel, a heat treatment to remove the stresses generated in forming and welding operations. This heat treatment is best done under controlled atmosphere or vacuum to maintain the mill finish. The fittings are not quenched, as in solution annealing; this would reintroduce residual stresses. Done correctly, parts are processed to provide minimum residual stresses and full corrosion resistance.

**Atmospheric Pressure** Force per unit area exerted against a surface by the weight of the air above that surface. At sea level, atmospheric pressure is 14.7 PSI.

**Automatic Welding** welding with equipment that performs the welding operation without adjustment of the controls by a welding operator. The equipment may or may not perform the loading and unloading of the work (see also machine welding).

**BEP** Best Efficiency Point. The point where the power coming out of the pump (water horsepower) is the closest to the power coming into the pump (brake horsepower) from the motor. This is also the point where there is no radial deflection of the shaft caused by unequal hydraulic forces acting on the impeller. Referred to as the sweet spot on the curve.

## Glossary

**BHP** Brake Horsepower. The actual amount of horsepower being consumed by the pump as measured on a pony brake or dynamometer. This is not the horsepower used by the motor or driver.

**Bioprocessing** the creation of a product utilizing a living organism

**Bioprocessing Equipment** equipment, systems or facilities used in the creation of products utilizing living organisms

**Bevel Seat Ferrules** A set of plain (male) and externally threaded (female) bushings with matching bevel angles that produce a leak-proof seal when connected with a hex union nut. The threads used are Acme form.

**Bright Anneal** Annealing in a protective medium to prevent scaling and discoloration of the surface.

**Bright Annealed Finish** A silvery satin surface, approximating the mill finish of stainless steel.

**Buna** Synthetic rubber, a copolymer of acrylonitrile and butadiene.

**Burst Pressure** The pressure at which rupture occurs.

**CCW** Counter clockwise

**C-Face/Frame** The NEMA standard for motor mounting dimensions.

**C<sub>v</sub>** The flow rate (in US gal/min) of pure water at 60°F passing through a valve when the valve is fully opened and the pressure differential between the two ends of the valve is 1 PSI.

- V = max. flow (in US gal/min)
- G = specific gravity (1 for water)
- P1 = inlet side pressure (psi)
- P2 = outlet side pressure (psi)

**CW** Clockwise

**Capacity** Flow rate normally measured in gallons per minute (GPM).

**Carbon/Graphite** A common mechanical seal face material chemically inert to most fluids with the exception of oxidizers, bleaches, halogens and a few other fluids.

**Cavitation** When the NPSH required by the pump is greater than the NPSH available in the system, cavitation occurs. Vapor is formed and moves along with the stream. These vapor bubbles or “cavities” collapse when they reach regions of higher pressure on their way through the pump cavities are forming in the liquid being pumped. When these cavities form at the suction of the pump several things happen all at once:

- Loss in capacity.
- Loss of head (pressure).
- The efficiency drops.
- The cavities or bubbles will collapse when they pass into the higher regions of pressure causing noise, vibration and damage to many of the components.

**Centipoise** Metric unit of viscosity

## Glossary

**Centistoke** The kinematic unit of viscosity. Viscosity in centipoise divided by the liquid density at the same temperature gives kinematic viscosity in centistokes.

**Centrifugal Pump** Moves liquid with centrifugal force.

**Ceramic** A hard, chemically inert seal face material that has very high compressive resistance.

**Clamp** A device used to join mechanical parts, fittings, ensuring a quick leak-proof connection and enabling easy tear down.

**Clean-In-Place (CIP)** internally cleaning a piece of equipment without relocation or disassembly. The equipment is cleaned but not necessarily sterilized. The cleaning is normally done by acid, caustic or a combination of both with water-for-injection (WFI) rinse.

**Close Coupled** The pump impeller is mounted directly to the motor shaft or stub shaft that is mounted directly on the motor shaft. There is no separate bearing case.

**Cold Flow** Continued deformation or movement of rubber or PTFE under stress.

**Compression Set** The deformation that remains in rubber or PTFE after it has been subjected to and released from stress such as a clamp. The longer the stress is maintained the more definitive the deformation.

**Controlled Sulfur** in weld ends of 316L materials used in BPE installations, the sulfur content must be between .005% and .017% to assure better orbital welding.

**Corrosion** a chemical or electrochemical interaction between a metal and its environment, which results in changes in the property of the metal. This may lead to impairment of the function of the metal, the environment and/or the technical system involved.

**Cycle** See Hertz

**DC** Direct current. The movement of electrical charge is only in one direction.

**DPDT** Double pole-double throw, a type of limit switch.

**Dead Head** The condition of a centrifugal pump running with a closed discharge line.

**Dilatent Fluid** Viscosity increases with shear.

**Discharge Head** The outlet pressure of a pump.

**Double-Acting (DA) Pneumatic Actuator** Any pneumatic actuator which uses air to drive the actuator output shaft in both the open and close direction. The air supply is piped to one side of a piston-drive or a diaphragm while the air contained on the opposing side is exhausted.

**Dry Running** Occurs when a pump is running with insufficient or no fluid in the pump.

**Durometer** An instrument for measuring the hardness of rubber by resistance to penetration.

## Glossary

**Durometer Hardness** A numerical value which indicates the resistance to indentation of the blunt indenter of the durometer.

**Dynamic Head (System Head)** A moving fluid exerts a pressure higher than the static pressure due to the kinetic energy of the fluid.

**EPDM** Ethylene propylene diene monomer, a synthetic rubber.

**Efficiency** Power out of the pump divided by power into the pump.

**Efficiency Formula:** 
$$\frac{\text{TDH} \times \text{GPM}}{\text{HP} \times 3960}$$

**Elastomer** Any of various elastic substances resembling rubber.

**Elastomeric Material** a material that can be stretched or compressed repeatedly and, upon immediate release of stress, will return to its approximate original size.

**Electropolishing** a controlled electrochemical process utilizing acid electrolyte, DC current, anode and cathode to smooth the surface by removal of metal.

**Electric Actuator** An electro-mechanical device used to open and close or modulate a valve. The actuator (which is mounted and coupled to the valve in similar fashion as the pneumatic actuator), operates the valve using an electric motor driving a gear train. While the basic function of the electric actuator is similar to the pneumatic, there are distinct differences in the application and flexibility of the two types, and these differences should be considered to select the proper type.

**Electric Fail-safe Actuator** Electrically driven actuator that contains an internal spring to close the valve on loss of electricity.

**Encapsulation** The enclosing of material by an encapsulant for protective purposes. In a ball valve the ball is encased in PTFE, for example, preventing the material flowing through the valve from getting behind the ball causing contamination problems.

**Eye of the Impeller** The center of the impeller where the fluid enters.

**Fail-Closed** Spring return pneumatic actuator is applied to the valve such that the spring will drive the valve to the closed position upon loss of air (may be termed air-to open).

**Fail-Open** Spring return pneumatic actuator is applied to the valve such that the spring will drive the valve to the open position upon loss of air (may be termed air-to close).

**Ferrule** A bushing used to secure a tube joint. A special bushing designed for welding to the end of tubing. Two ferrules and a gasket make a leak-proof connection when used with the complimentary clamps.

**Fitting** A small part of an apparatus (may be detachable).

**Flooded Suction** When the liquid source is higher than the pump and the liquid flows to the pump by gravity. Preferable for centrifugal pump installations.

## Glossary

**Flow** See *capacity*

**Flow Coefficient ( $C_v$ )** The flow in U.S. gallons of water (at 60°F) that will pass through the valve in one minute with a differential pressure across the valve of 1 PSI.

**Fluid End** The portion of the pump that comes in contact with the fluid being pumped.

**Fluorocarbon** Elastomer known as FKM a registered trademark of DuPont. (FKM is generic equivalent)

**Fluoropolymer** polymer material having a carbon chain either partially or completely bonded to fluorine atoms. FKM (FKM) and PTFE are examples of this material type.

**Foot Valve** A type of check valve. Used at the point of the liquid intake to retain liquid in the system, preventing the loss of prime when the liquid source is lower than the pump.

**Frame** See *C-Face*

**Friction Head** The pressure needed to overcome the resistance to the flow in the pipe and fittings.

**Friction Loss** The part of the total loss that occurs as the fluid flows through straight pipe.

**Gas Tungsten-Arc Welding (GTAW)** an arc welding process that produces coalescence of metals by heating them with an arc between a tungsten (non-consumable) electrode and the work. Shielding is obtained from a gas or gas mixture. (This process is sometimes called TIG welding, a non-preferred term.) GTAW may be performed by adding filler material to the weld or by a fusion process in which no filler is added.

**Gasket** Static seal made from deformable material compressed between two mating surfaces.

**GPM** Gallons per minute

**Hard Face** A seal face either rotating or stationary. The most common materials are silicon carbide, ceramic and tungsten carbide.

**Head** The equivalent height of the liquid. 20°C water is used as the standard where 33.9ft of water equals one atmosphere (14.7psi). The pressure in a column of liquid. Pressure will increase as the height of the column increases. Head refers to the height in feet: pressure refers to the PSI. Centrifugal pump discharge is measured in head.

**Heat Number** an alphanumeric identification of a stated tonnage of metal obtained from a continuous melting in a furnace.

**Heat-Affected Zone** that portion of the base metal that has not been melted, but whose microstructure or mechanical properties have been altered by the heat of welding or cutting.

**Hertz** Frequency (cycles per seconds)

**Hex Union Nut** An internally acme-threaded six-sided connector used to assemble some fittings.

**Horsepower** Unit for measurement of power or rate of work. One horsepower = 33,000 foot pounds per minute.

## Glossary

**Hygienic Clamp Joint** a tube outside diameter union consisting of two neutered ferrules having flat faces with a concentric groove and mating gasket that is secured with a clamp, providing a non-protruding, recessless product contact surface.

**ISO 5211** International standard for actuator and valve interface

**Impeller** A rotor or rotor blade attached to the end of the stub shaft imparting energy from the motor to the fluid being pumped

**Internal Expansion (IX)** A method using a stem and a ferrule to assemble ends on a hose. Upon assembly of the parts, a plug, sometimes known as a bullet, or a set of blades (fingers) is used to expand the stem diameter to a new larger size where the serrations on the stem are forced into the hose and this, in turn, forces the hose cover into the serrations of the ferrule. This provides a permanent assembly.

**Kinetic Energy** Created by a centrifugal pump when the velocity of the fluid is accelerated to the outer rim of the impeller. The amount of kinetic energy given to the fluid corresponds to the velocity at the impeller vane tip. The faster the impeller revolves or the bigger the impeller, the greater the energy given to the fluid. This kinetic energy is then harnessed and slowed by the resistance created by the pump volute.

**Laminar Flow** Sometimes known as streamline flow, occurs when a fluid flows in parallel layers, with no disruption between the layers. In fluid dynamics, laminar flow is a flow regime characterized by high momentum diffusion and low momentum convection. It is the opposite of turbulent flow. In nonscientific terms laminar flow is "smooth", while turbulent flow is "rough." Laminar flow is common in viscous fluids, especially those moving at low velocities.

**Lubricant** Any fluid that will maintain a film thickness of one micron or more at its operating temperature and load.

**Machine Welding** welding with equipment that performs the welding operation under the constant observation and control of a welding operator. The equipment may or may not perform the loading and unloading of the works. (see also automatic welding).

**Manual Override** Any mechanical device by which an automated valve may be manually operated. On smaller actuators, this may simply be wrench flats on the output shaft of the actuator. Larger actuators may require a more sophisticated system, such as de-clutchable hand wheels, manual gears, jack screws or hydraulic hand pump over-ride.

**Manual Welding** welding in which the entire welding operation is performed and controlled by hand.

**Maximum-Shut-Off Pressure (Delta-P)** The pressure of the media flowing into the valve against which the valve will have to close.

**Meandering** of or pertaining to a weld bead that deviates from side to side across the weld joint rather than tracking the joint precisely. Note the controlled sulfur content in BPE weld material.

**Mechanical Seal** A positive sealing device used to seal all fluids. Consists of two basic parts, a rotating element attached to the pump shaft and a stationary element attached to the pump casing. Each of these elements has a highly polished sealing surface. The polished faces of the rotating and stationary elements come into contact with each other to form a seal that prevents leakage along the shaft.

**Media** The material flowing through the valve.

## Glossary

**Modulating Service** Proportional positioning of a valve between the open and closed position. Used for flow control processes.

**MTR** Material Test Report

**NAMUR** International Standard of Interface for actuator accessories connections.

**NEMA** National Electrical Manufacturers Association

**NEMA Rating** National electrical code ratings for electrical component enclosures.

**NEMA 4** Weather-proof enclosure suitable for indoor/outdoor applications to protect from windblown dust, rain or hose-directed water.

**NEMA 4x** Offers the same protection as NEMA 4 with the addition of corrosion resistance.

**NEMA 6** Enclosure that may be submerged up to six feet for 30 minutes.

**NEMA 7** Enclosure for hazardous locations must be capable of withstanding an internal explosion of gases so as not to ignite an external gas-air mixture.

**NPSH(a)** Net positive suction head available is the amount of fluid pressure you have at the suction side of the pump due to atmospheric pressure, pressurized tank or other means.

**NPSH(r)** Net positive suction head required is the amount of fluid pressure required at the suction to prevent cavitation. This requirement is found on pump curves produced by each pump manufacturer.

**Net Positive Suction Head** Amount of energy in the liquid at the pump datum. It must be defined to have a meaning, as either available or required NPSH.

**Neoprene** Synthetic rubber, chemically and structurally similar to natural rubber.

**Nick** a surface void anomaly caused by material removal or compression from the surface, whose bottom surface is usually irregular.

**Nominal Size** A dimensional value assigned for the purpose of convenient designation.

**ODP** Open Drip Proof motor enclosure

**On-Off Service** When the valve is being used to start or stop flow by being cycled to the full open or full closed position

**Operating Pressure** The pressure at which system functions. Also known as working pressure.

**Orbital Welding** automatic or machine welding of tubes or pipe in-place with the electrode rotating (or orbiting) around the work. Orbital welding can be done with the addition of filler material or as a fusion process without the addition of filler.

**PSI** Pounds per square inch



## Glossary

**PSIG** Pounds per square inch gauge

**PTFE** Tetrafluoroethylene, is a high performance thermo plastic polymer that has excellent dielectric strength, chemical and temperature resistance.

**Passivation** removal of exogenous iron or iron from the surface of stainless steels and higher alloys by means of a chemical dissolution, most typically by a treatment with an acid solution that will remove the surface contamination and enhance the formation of the passive layer.

**Pipe** pipe size is determined by diameter and either schedule, series or SDR. For bioprocessing equipment, pipe does not include tube.

**Pipe Friction Loss** The positive head (fluid pressure) loss due to friction resistance between the pipe walls and the moving liquid.

**Pit** a small surface void resulting from a localized loss of base material.

**Pneumatic Actuator** An air operated mechanical device used to open and close or modulate a valve. The actuator, which is mounted to the valve by a bracket and coupled to the stem, is designed to convert air pressure into mechanical force sufficient to operate the valve.

**Polish** To make smooth and shiny by rubbing. Fittings may be machine polished to 180 grit finish.

**Polypropylene** A lightweight synthetic plastic.

**Positive Displacement Pump** A pump that causes a fluid to move by trapping a fixed amount of it then forcing (displacing) that trapped volume into the discharge pipe.

**Pressure** The force per unit area applied on a surface in a direction perpendicular to that surface.

**Pressure Head** Must be considered when a pumping system either begins or terminates in a tank which is under some pressure other than atmospheric. The pressure in such a tank must first be converted to feet of liquid. A vacuum in the suction tank or a positive pressure in the discharge tank must be added to the system head, whereas a positive pressure in the suction tank or vacuum in the discharge tank would be subtracted. The following is a handy formula for converting inches of mercury vacuum into feet of liquid.

$$\text{Vacuum, in. of Hg} \times 1.13$$

$$\text{Vacuum, ft of liquid} = \text{Sp. Gr.}$$

The above forms of head, namely static, friction, velocity, and pressure, are combined to make up the total system head at any particular flow rate.

**Pressure Rating** pressure at which a system is designed to operate, allowing for applicable safety factors.

**Prime.** A charge of liquid required beginning the pumping action of centrifugal pumps when the liquid source is lower than the pump.

**Profilometer** an instrument for the measurement of the degree of surface roughness.

## Glossary

**R<sub>a</sub>** log of the arithmetic mean of the surface profile.

**RPM** Revolutions per minute

**SPDT** Single pole double throw, a type of limit switch.

**SPST** Single pole single throw, a type of limit switch.

**STP** Standard conditions for temperature and pressure. In physical sciences, STP, are standard sets of conditions for experimental measurements, to allow comparisons to be made between different sets of data. National Institute of Standard and Technology's (NIST) version is a temperature of 20°C (293.15 K, 68°F) and an absolute pressure of 101.325 kPa (14.696 PSI, 1 atm).

**Sanitary (hygienic) Weld** generally considered to be a groove weld in a square butt joint made by the GTAW (or plasma) process as a fusion weld without the addition of filler material. A sanitary weld must be completely penetrated on the weld ID, with little or no discoloration due to oxidation and be otherwise without defects that would interfere with maintenance in a clean and sterile condition.

**Santoprene** A thermoplastic elastomer, a rubber-like material that complies to FDA requirements.

**Schedule** dimensional standard for pipe as defined by ASTM.

**Seal Face** surface point on which a seal is achieved.

**Service Temperature** The maximum and minimum temperature of the media.

**Shut-Off Head** The maximum head that a pump can generate.

**Silicon Carbide** Synthetic mineral of silicon and carbide. It is used in abrasives, refractories, ceramics and numerous high performance applications.

**Silicone** Dimethyl silicone, a synthetic rubber.

**Sintering** Heat process in which powdered metal particles are heated to near melting point, fusing the metal granules together.

**Specific Gravity** A measure of the weight of a liquid in relation to that of water. If the liquid in question will float on water then the specific gravity will be less than one and if the liquid will sink when mixed with water the specific gravity will be greater than one.

**Spring-Return (SR) Pneumatic Actuator** Any pneumatic actuator which contains a single coil spring or group of coil springs to oppose the movement of a piston or diaphragm. As air moves the piston or diaphragm the spring is compressed. When the air supply is discontinued and exhausted, the spring extends and drives the piston or diaphragm in the opposite direction. This type of actuator is normally used for applications where it is necessary for the valve to move to the open or close position upon loss of air supply, whether by design or by system failure.

**Static Discharge Head** The vertical distance in feet between the pump center line and the point of free discharge or the surface of the liquid in the discharge tank.

## Glossary

**Static Head** The pressure at any point in a liquid can be thought of as being caused by a vertical column of the liquid which, due to its weight, exerts a pressure equal to the pressure at the point in question. The height of this column is called the "static head" and is expressed in terms of feet of liquid.

**Stem Torque** The force required at the valve stem to open or close the valve against system pressure and service conditions.

**Suction Head** Exists when the source of supply is above the center line of the pump. Thus the static suction head is the vertical distance in feet from the center line of the pump to the free level of the liquid to be pumped.

**Suction Lift** Exists when the source of supply is below the center line of the pump. Thus the static suction lift is the vertical distance in feet from the center line of the pump to the free level of the liquid to be pumped.

**Supply Pressure** The plant air supply pressure available to operate a pneumatic actuator. (plant air)

**Surface Finish** all surfaced as defined by Part SF of the current ASME BPE Standard and/or the owner/user or manufacturer and referred in  $R_a$   $\mu\text{in.}$  or  $\mu\text{m.}$

**Surge** Also known as water hammer. A rapid rise or decrease of internal pressure. Surge conditions occur for various reasons, typically, but not limited to: start and stop sequences.

**System Curve** A description of what the pump is required to perform. The pump will pump where the system curve intersects the pump curve.

**System Head** The head caused by friction in the piping valves and fittings.

**TDH** Total dynamic head. A combination of the suction head and the head being produced by the pump. Discharge reservoir pressure head + static discharge head + velocity head at pump discharge + total friction head in discharge line.

**TEFC** Totally Enclosed Fan Cooled motor enclosure.

**TENV** Totally Enclosed Non Ventilated motor enclosure.

**Thixotropic Fluid** Viscosity thins with shear.

**Torque** A twisting or turning force. Usually measured in inch pounds (in-lbs) or foot pounds (ft-lbs). (Force through a distance.)

**Total Dynamic Discharge Head** (hd) The static discharge head plus the velocity head at the pump discharge flange plus the total friction head in the discharge line. The total dynamic discharge head, as determined on pump test, is the reading of a gauge at the discharge flange, converted to feet of liquid and corrected to the pump center line, plus the velocity head at the point of gauge attachment.

**Total Dynamic Suction Head** (hs) The static suction head plus the velocity head at the pump suction flange minus the total friction head in the suction line. The total dynamic suction head, as determined on pump test, is the reading of the gauge on the suction flange, converted to feet of liquid and corrected to the pump centerline, plus the velocity head at the point of gauge attachment.

## Glossary

**Total Dynamic Suction Lift** (hs) The static suction lift minus the velocity head at the pump suction flange plus the total friction head in the suction line. The total dynamic suction lift, as determined on pump tests, is the reading of a gauge on the suction flange, converted to feet of liquid and corrected to the pump centerline, minus the velocity head at the point of gauge attachment.

**Total Head** (H) or **Total Dynamic Head** The total dynamic discharge head minus the total dynamic suction head or plus the total dynamic suction lift.

$$\text{TDH} = \text{hd} + \text{hs} \text{ (with suction lift)}$$

$$\text{TDH} = \text{hd} - \text{hs} \text{ (with a suction head)}$$

**Total Static Head** The vertical distance in feet between the free level of the source of supply and the point of free discharge or the free surface of the discharge liquid.

**Tube** A hollow cylinder especially one that conveys a fluid. For sanitary applications a thin wall is implied.

**Tube Fitting** A length of tubing formed into a usable shape either welded to an apparatus or welded to ferrules for use in an apparatus.

**Tubing** A piece or length of tube.

**Tumble Polish Surface** A uniform finish applied by vibratory equipment to stainless steel, varying from matte grey to bright, depending on media used. This process may cause work hardening on the surfaces.

**Tungsten Carbide** A common hard face seal material available in several grades depending upon hardness and corrosion resistance. Cobalt and nickel are the two most common binders.

**Turbulent Flow** Irregular flow that is characterized by tiny whirlpool regions. The velocity of this fluid is definitely not constant at every point.

**VFD** Variable Frequency Drive. Used to vary the frequency going into a motor, thus varying the speed at which the motor runs.

**Vapor Pressure** Below this pressure the liquid being pumped will vaporize.

**Vaporize** The fluid passes from a liquid to a gaseous state.

**Velocity** A measurement of the speed of the liquid in the system; Velocity = distance/time.

**Velocity Head** (hv) The energy of a liquid as a result of its motion at some velocity V. It is the equivalent head in feet through which the water would have to fall to acquire the same velocity, or in other words, the head necessary to accelerate the water.

Velocity head can be calculated from the following formula:

$$H = \frac{V^2}{2g}$$

where  $g = 32.2 \text{ ft/second}^2$

$V = \text{liquid velocity in feet per second}$

The velocity head is usually insignificant and can be ignored in most high head systems. However, it can be a large factor and must be considered in low head systems

## Glossary

**Viscosity** Resistance to flow. Internal friction of a liquid tending to reduce flow.

**FKM** A DuPont manufactured elastomer widely used in the sealing industry. FKM is the generic equivalent.

**Volute (casing)** Casing surrounding the pump impeller. The volute converts velocity energy to pressure energy.

**WOG** Water, Oil, Gas. Pressure rating for valves handling these products. This does not include steam.

**WHP** Water Horse Power. The calculated horse power coming out of the pump.

$$\text{WHP} = \frac{\text{head} \times \text{gpm}}{3960}$$

**Washdown Duty** Motor enclosure that is suitable for a liquid washdown atmosphere.

**Water Hammer** See *surge*

**Waviness** undulations or rippling of the surfaces.

**Welding** Join two (or more) pieces of material by applying heat to produce a localized union through fusion across the interface. For sanitary fittings, a ferrule is attached to the ends of a tube fitting by TIG welding without the addition of filler metal. Tube fittings can then be joined with clamps and gaskets to form parts of a system.

**Work (Strain) Hardening.** An increase in hardness and strength caused by plastic deformation at temperatures below the annealing ranges.



## Limited Warranty

Dixon Sanitary, a division of Dixon Valve and Coupling Company, (herein called Dixon Sanitary) warrants the products described herein, and manufactured by Dixon Sanitary to be free from defects in material and workmanship for a period of one (1) year from date of shipment by Dixon Sanitary under normal use and service. It's sole obligation under this warranty being limited to repairing or replacing, as hereinafter provided, at its option any product found to Dixon Sanitary's satisfaction to be defective upon examination by it, provided that such product shall be returned for inspection to Dixon Sanitary within three (3) months after discovery of the defect. The repair or replacement of defective products will be made without charge for parts or labor. This warranty shall not apply to: (a) parts or products not manufactured exclusively for Dixon Sanitary, the warranty of such items being limited to the actual warranty extended to Dixon Sanitary by its supplier; (b) any product that has been subject to abuse, negligence, accident, or misapplication; (c) any product altered or repaired by others than Dixon Sanitary; and (d) to normal maintenance services and the replacement of service items (such as gaskets and seats) made in connection with such services. To the extent permitted by State law, this limited warranty shall extend only to the buyer and any other person reasonably expected to use or consume the goods who is injured in person by any breach of the warranty. No action may be brought against Dixon Sanitary for an alleged breach of warranty unless such action is instituted within one (1) year from the date the cause of action accrues. This limited warranty shall be construed and enforced to the fullest extent allowable by applicable State law.

OTHER THAN THE OBLIGATION OF DIXON SANITARY SET FORTH HEREIN, DIXON SANITARY DISCLAIMS ALL WARRANTIES, EXPRESS OR IMPLIED, INCLUDING BUT NOT LIMITED TO ANY IMPLIED WARRANTIES OF MERCHANTABILITY OR FITNESS FOR A PARTICULAR PURPOSE, AND ANY OTHER OBLIGATION OR LIABILITY. THE FOREGOING CONSTITUTES BRADFORD'S SOLE OBLIGATION WITH RESPECT TO DAMAGES, WHETHER DIRECT, INCIDENTAL OR CONSEQUENTIAL, RESULTING FROM THE USE OR PERFORMANCE OF THE PRODUCT.

Some products and sizes may be discontinued when stock is depleted, or may require a minimum quantity for ordering.

NOTE: Reasonable care has been taken in preparing this catalog. Dixon Sanitary, a division of Dixon Valve & Coupling Company, reserves the right to make corrections and any dimensional changes.

Dixon, founded in 1916, is a premier manufacturer and supplier of hose couplings, valves, dry-disconnects, swivels, and other fluid transfer and control products. The company's global reach includes a wide range of products for numerous industries including petroleum exploration, refining, transportation, chemical processing, food & beverage, steel, fire protection, construction, mining and manufacturing. Dixon's strategic objective is to create solutions that make products safer, leak-free, longer lasting, and always available.



*The Right Connection®*

## **Dixon Sanitary**

N25 W23040 Paul Road • Pewaukee, WI 53072

Customer Service: 800.789.1718

Fax: 800.789.4046

**dixonvalve.com**