



The Right Connection®

Hose Catalogue



Customer Service: **+44 (0)1772 323529**



www.dixoneurope.co.uk

Dixon Group Europe is a specialist supplier of industrial hose and hose assemblies; we are certified to the Pressure Equipment Directive 2014/68/EU to manufacture flexible hose assemblies positioning us as a market leader in this field.

At Dixon we are driven to provide 'the right connection' in meeting specific hose requirements across all industries. Our strength in service, support and advice ensure the correct specification of bespoke hose assemblies and couplings.

With manufacturing and engineering facilities approved to BSI ISO 9001 and with over a 100 years' experience, Dixon can design and produce fully tested and certified customised hose solutions to meet and resolve our customers' fluid & air handling challenges.



Certificate No. Q 09970

Hose Catalogue

Air & Water

A101AS-T3.....	4
A101HP.....	4
A102HP.....	5
A103HP.....	5
A105HP.....	6
A116EU100.....	6
A190.....	7
A190Y.....	7
A210.....	8
A216.....	8
Delvac.....	9
Irribulk.....	9

Food & Beverage

SANB.....	10
SANF.....	10
SAN-SIL.....	11
Delikatesse.....	11
PREMVIN.....	12

Oil, Chemical & General Purpose

BAKU.....	13
A104.....	13
A110.....	14
A125.....	14
A420.....	15
A430.....	15
A460.....	16
A400EU.....	16

A410.....	17
A416.....	17
A901GG.....	18
A901AG.....	18
A906PG.....	19
A911SG.....	19

Steam

A230.....	20
A235BK.....	20
A235BU.....	21

Abrasive

A361.....	22
Premflex.....	22

Metallic & PTFE

Metallic.....	23
PTFE.....	26
Metallic & PTFE Assemblies.....	29

Specialist & Custom Built

Bulkstream.....	30
Heat Traced Hose.....	30
GSM Hose.....	31

Hose Fittings & Accessories.....

Technical Information.....

Terms & Conditions.....



A

A101AS-T3 - Dixon Anti-Static Air/Water Hose 20 Bar



Technical Characteristics	
Application	Widely used in offshore oil and gas industries where a spark free environment is crucial
Cover	Black smooth extruded, anti-static, abrasion, oil mist, ozone and weather resistant EPDM
Branding	DIXON A101AS T3 AIR WATER 20 BAR 3:1 BS2878
Reinforcement	High tensile strength textile plies
Lining	Black extruded anti-static, oil mist resistant EPDM
Temperature	From -30°C to +80°C intermittent use up to 100°C
Safety Factor	3:1

Sizes					
I.D (mm)	O.D (mm)	Max Working Pressure (Bar)	Min Burst Pressure (Bar)	Min Bend Radius (mm)	Weight (Kg/Mtr)
6	14	20	60	55	0.21
10	17	20	60	75	0.24
13	20.5	20	60	100	0.31
19	29	20	60	120	0.56
25	36	20	60	150	0.70

A101HP - Dixon Air/Water Hose 20 Bar



Technical Characteristics	
Application	Used in various air and water applications in agriculture, construction, plant & civil engineering
Cover	Black smooth extruded, abrasion, ozone and weather resistant EPDM/SBR
Branding	DIXON A101HP AIR/WATER BS5118/2 & ISO2398 20 BAR SF 3:1
Reinforcement	High tensile strength textile plies
Lining	Black extruded oil mist resistant NR/SBR
Temperature	From -20°C to +80°C
Safety Factor	3:1

Sizes					
I.D (mm)	O.D (mm)	Max Working Pressure (Bar)	Min Burst Pressure (Bar)	Min Bend Radius (mm)	Weight (Kg/Mtr)
6	13	20	60	60	0.18
8	15	20	60	80	0.21
10	17	20	60	100	0.25
13	21	20	60	130	0.35
19	29	20	60	190	0.48
25	36	20	60	250	0.67

All Hose Assemblies compliant with Pressure Equipment Directive 2014/68/EU

We reserve the right to change hose specifications without prior notice

A102HP - Dixon Air/Water Hose 20 Bar



Technical Characteristics	
Application	Used in various air and water applications in agriculture, construction, plant & civil engineering
Cover	Yellow smooth extruded, abrasion, ozone and weather resistant EPDM/SBR
Branding	DIXON A102HP AIR/WATER BS5118/2 & ISO2398 20 BAR SF 3:1
Reinforcement	High tensile strength textile plies
Lining	Black extruded oil mist resistant NR/SBR
Temperature	From -20°C to +80°C
Safety Factor	3:1

Sizes					
I.D (mm)	O.D (mm)	Max Working Pressure (Bar)	Min Burst Pressure (Bar)	Min Bend Radius (mm)	Weight (Kg/Mtr)
13	21	20	60	130	0.35
19	29	20	60	190	0.48
25	36	20	60	250	0.67

A103HP - Dixon Multi Utility Hose 20 Bar



Technical Characteristics	
Application	Multi-purpose hose used in steel mills, shipyard, foundries, automotive and construction industries. For use in wide range of media including air, water and inert gases
Cover	Blue smooth extruded, oil mist, abrasion, ozone and weather resistant EPDM/SBR
Branding	DIXON A103HP Multi Utility 20 BAR SF 3:1
Reinforcement	High tensile strength textile plies
Lining	Black extruded SBR/NR oil mist resistant
Temperature	From -20°C to +90°C
Safety Factor	3:1

Sizes					
I.D (mm)	O.D (mm)	Max Working Pressure (Bar)	Min Burst Pressure (Bar)	Min Bend Radius (mm)	Weight (Kg/Mtr)
19	29	20	60	190	0.65
25	36	20	60	250	0.88

All Hose Assemblies compliant with Pressure Equipment Directive 2014/68/EU

We reserve the right to change hose specifications without prior notice

A

A105HP - DIXON Multi Utility Hose 20 Bar



Technical Characteristics	
Application	Multi-purpose hose used in steel mills, shipyard, foundries, automotive and construction industries. For use in wide range of media including air, water and inert gases
Cover	Green smooth extruded, oil mist, abrasion, ozone and weather resistant EPDM/SBR
Branding	DIXON A105HP Multi Utility 20 BAR SF 3:1
Reinforcement	High tensile strength textile plies
Lining	Black extruded SBR/NR oil mist resistant
Temperature	From -20°C to +90°C
Safety Factor	3:1

Sizes					
I.D (mm)	O.D (mm)	Max Working Pressure (Bar)	Min Burst Pressure (Bar)	Min Bend Radius (mm)	Weight (Kg/Mtr)
19	29	20	60	190	0.65
25	36	20	60	250	0.88

A116EU100 - Dixon High Temperature Air Hose 40 Bar



Technical Characteristics	
Application	Robust heavy duty high pressure air hose for quarry, mining and construction industries
Cover	Yellow pin pricked, mandrel wrap, ozone, oil mist and weather resistant EPDM
Branding	DIXON LOGO A116EU100 AIR 40 BAR S:F 3:1 TEMP 100°C
Reinforcement	High tensile strength steel wire plies
Lining	Black SBR oil mist resistant
Temperature	From -30°C to +100°C
Safety Factor	3:1

Sizes					
I.D (mm)	O.D (mm)	Max Working Pressure (Bar)	Min Burst Pressure (Bar)	Min Bend Radius (mm)	Weight (Kg/Mtr)
51	65	40	120	510	1.97
76	95	40	120	760	4.33
102	121	40	120	1020	5.65

All Hose Assemblies compliant with Pressure Equipment Directive 2014/68/EU

We reserve the right to change hose specifications without prior notice

A190 - Dixon Air/Water Hose 20 Bar



Technical Characteristics	
Application	Robust mandrel built hose for arduous applications in mining and construction
Cover	Black mandrel wrap, abrasion, ozone and weather resistant SBR
Branding	DIXON LOGO, A190 AIR WATER EN 2398 2008 - 20 BAR - SF 3:1
Reinforcement	High tensile strength textile plies
Lining	Black SBR oil mist resistant
Temperature	From -20°C to +70°C
Safety Factor	3:1

Sizes					
I.D (mm)	O.D (mm)	Max Working Pressure (Bar)	Min Burst Pressure (Bar)	Min Bend Radius (mm)	Weight (Kg/Mtr)
13	23	20	60	91	0.40
19	30	20	60	133	0.60
25	37	20	60	175	0.70
32	46	20	60	224	1.30
38	52	20	60	266	1.50
51	65	20	60	357	1.90
76	92	20	60	532	3.20

A190Y - Dixon Air/Water Hose 20 Bar



Technical Characteristics	
Application	Robust mandrel built hose for arduous applications in mining and construction
Cover	Yellow mandrel wrap, abrasion, ozone and weather resistant SBR
Branding	DIXON LOGO, A190 AIR WATER EN 2398 2008 - 20 BAR - SF 3:1
Reinforcement	High tensile strength textile plies
Lining	Black SBR oil mist resistant
Temperature	From -20°C to +70°C
Safety Factor	3:1

Sizes					
I.D (mm)	O.D (mm)	Max Working Pressure (Bar)	Min Burst Pressure (Bar)	Min Bend Radius (mm)	Weight (Kg/Mtr)
13	23	20	60	91	0.40
19	30	20	60	133	0.60
25	37	20	60	175	0.70
32	46	20	60	224	1.30
38	52	20	60	266	1.50
51	65	20	60	357	1.90
76	92	20	60	532	3.20

All Hose Assemblies compliant with Pressure Equipment Directive 2014/68/EU

We reserve the right to change hose specifications without prior notice

A210 - Dixon Water Suction & Delivery Hose 10 Bar



Technical Characteristics	
Application	Industrial hose for water and mild abrasives. For use in construction and civil engineering
Cover	Black mandrel wrap, ozone and weather resistant SBR
Branding	DIXON LOGO, A210 WATER S&D 10 BAR/700mmHg SF 3:1
Reinforcement	High tensile strength textile plies, carbon wire helix
Lining	Black SBR
Temperature	From -20°C to +70°C
Safety Factor	3:1

Sizes					
I.D (mm)	O.D (mm)	Max Working Pressure (Bar)	Min Burst Pressure (Bar)	Min Bend Radius (mm)	Weight (Kg/Mtr)
25	35	10	30	150	0.80
32	43	10	30	190	1.00
38	47	10	30	266	1.00
51	62	10	30	357	1.80
63	74	10	30	441	2.20
76	87	10	30	532	2.80
102	114	10	30	714	4.30
152	169	10	30	1064	9.50

A216 - Dixon Water Suction & Delivery Hose 16 Bar



Technical Characteristics	
Application	Industrial hose for water and mild abrasives. For use in construction and civil engineering
Cover	Black mandrel wrap, abrasion, ozone and weather resistant SBR
Branding	DIXON LOGO A216 WATER S&D 16 BAR SF 3:1 BAR
Reinforcement	High tensile strength textile plies, double helix
Lining	Black SBR
Temperature	From -35°C to +70°C
Safety Factor	3:1

Sizes					
I.D (mm)	O.D (mm)	Max Working Pressure (Bar)	Min Burst Pressure (Bar)	Min Bend Radius (mm)	Weight (Kg/Mtr)
51	66	16	48	200	2.23
76	91	16	48	350	3.22
102	120	16	48	500	4.80
127	145	16	48	600	5.54
152	174	16	48	800	9.02
203	225	16	48	1100	12.61

All Hose Assemblies compliant with Pressure Equipment Directive 2014/68/EU

We reserve the right to change hose specifications without prior notice

DELVAC - PVC Suction & Delivery Hose



Technical Characteristics	
Application	Low pressure generic hose for water and dilute chemicals. For use in agriculture, construction and water utility industries
Construction	Transparent Green PVC according to EU10/2011
Branding	DIXON DELVAC
Reinforcement	PVC spiral helix
Temperature	-10°C TO +55°C
Safety Factor	3:1

Sizes						
I.D (mm)	O.D (mm)	Max Working Pressure (Bar)	Min Burst Pressure (Bar)	Vacuum	Min Bend Radius (mm)	Weight (Kg/Mtr)
19	25	8	24	0.7	86	0.28
25	32	6.5	19.5	0.7	114	0.33
32	39	5.5	16.5	0.7	143	0.46
38	45	4.5	13.5	0.7	171	0.55
51	60	4.5	13.5	0.7	230	0.81

IRRIBULK - PVC Suction & Delivery Hose



Technical Characteristics	
Application	Medium Duty hose for water, slurry, abrasives and chemicals. For use in agriculture, construction and civil engineering industries
Construction	Olive Green PVC according to EU10/2011
Branding	DIXON IRRIBULK M
Reinforcement	PVC spiral helix
Temperature	-10°C TO +55°C
Safety Factor	3:1

Sizes						
I.D (mm)	O.D (mm)	Max Working Pressure (Bar)	Min Burst Pressure (Bar)	Vacuum	Min Bend Radius (mm)	Weight (Kg/Mtr)
25	32	8	24	0.78	57	0.36
32	39	7	21	0.78	72	0.46
38	46	6.3	19	0.78	86	0.57
51	60	5.3	16	0.78	114	0.83
63	73	5	15	0.78	143	1.05
76	86	4.3	13	0.78	171	1.47
102	113	4	12	0.78	284	2.17
152	166	3.3	10	0.6	401	4.22

All Hose Assemblies compliant with Pressure Equipment Directive 2014/68/EU

We reserve the right to change hose specifications without prior notice

SANB - Dixon San-Hygienic Brew Suction & Delivey Hose 10 bar



Technical Characteristics	
Application	For the transfer of liquid food stuffs including fatty oils, alcohol and potable water
Cover	Red smooth cloth finish and resistant to vegetable oils and fats, abrasion, weather & ozone
Approvals	FDA 21 CFR 177.2600; BfR Recommendation XXI CAT 2
Reinforcement	Synthetic plies, twin carbon steel helices
Lining	NBR white food quality
Temperature	From -20°C to +90°C
Safety Factor	3:1

Sizes					
I.D (mm)	O.D (mm)	Max Working Pressure (Bar)	Min Burst Pressure (Bar)	Min Bend Radius (mm)	Weight (Kg/Mtr)
19	31	10	30	95	0.72
25	37	10	30	125	0.90
32	44	10	30	150	1.01
38	51	10	30	190	1.40
51	64	10	30	255	1.80
63	77	10	30	315	2.75
76	92	10	30	380	3.56
102	122	10	30	510	5.91

SANF - Dixon San-Hygienic Food Suction & Delivey Hose 10 bar

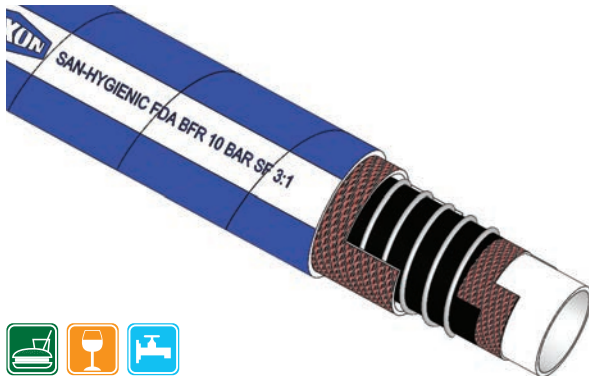

Technical Characteristics	
Application	For the transfer of liquid food stuffs including fatty oils, alcohol and potable water
Cover	Blue smooth cloth finish and resistant to vegetable oils and fats, abrasion, weather & ozone
Approvals	FDA 21 CFR 177.2600; BfR Recommendation XXI CAT 2
Reinforcement	Synthetic plies, twin carbon steel helices
Lining	NBR white food quality (FDA Specification)
Temperature	From -20°C to +90°C (additional temp for CIP)
Safety Factor	3:1

Sizes					
I.D (mm)	O.D (mm)	Max Working Pressure (Bar)	Min Burst Pressure (Bar)	Min Bend Radius (mm)	Weight (Kg/Mtr)
19	31	10	30	95	0.72
25	37	10	30	125	0.90
32	44	10	30	150	1.01
38	51	10	30	190	1.40
51	64	10	30	255	1.80
63	77	10	30	315	2.75
76	92	10	30	380	3.56
102	122	10	30	510	5.91

All Hose Assemblies compliant with Pressure Equipment Directive 2014/68/EU

We reserve the right to change hose specifications without prior notice

SANSIL - DIXON Silicone Suction & Delivery Hose



Technical Characteristics	
Application	For use in Pharmaceutical, food & beverage applications in health and personal care industries
Cover	Translucent seamless extruded silicone, Platinum cured
Approvals	FDA 21 CFR 177.2600; USP CLASS VI
Reinforcement	Polyester fabrics, 316L stainless steel helix
Lining	FDA approved transparent seamless smooth silicone, Platinum cured
Temperature	From -40°C to +200°C
Safety Factor	4:1

Sizes					
I.D (mm)	O.D (mm)	Max Working Pressure (Bar)	Min Burst Pressure (Bar)	Min Bend Radius (mm)	Weight (Kg/Mtr)
13	25	10	40	45	0.39
19	31	10	40	65	0.63
25	38	10	40	80	0.84
32	44	10	40	120	0.99
38	51	10	40	150	1.38
51	63	10	40	180	1.87
63	76	7	28	220	2.23
76	89	4	16	250	2.98
102	114	3	12	360	3.99

DELIKATESSE - PVC Non Toxic Suction & Delivery Hose



Technical Characteristics	
Application	Lightweight flexible hose for use with various food stuffs or solids even at low temperature
Construction	Transparent green food grade PVC
Branding	DIXON DELIKATESSE
Reinforcement	PVC spiral helix, smooth bore
Temperature	-10°C TO +55°C
Safety Factor	3:1

Sizes						
I.D (mm)	O.D (mm)	Max Working Pressure (Bar)	Min Burst Pressure (Bar)	Vacuum	Min Bend Radius (mm)	Weight (Kg/Mtr)
25	32	8	24	0.68	114	0.33
32	39	7	21	0.68	143	0.46
38	45	6.5	19.5	0.68	171	0.55
51	60	6	18	0.68	230	0.81
63	72	5	15	0.68	284	1.04
76	86	4	12	0.68	342	1.38

All Hose Assemblies compliant with Pressure Equipment Directive 2014/68/EU

We reserve the right to change hose specifications without prior notice

PREMVIN - Food & Bulk PVC Suction & Delivery Hose



Technical Characteristics	
Application	Food grade PVC hose for abrasive and non-abrasive solids or liquids including diluted chemicals
Construction	Clear food quality PVC according to EU10/2011
Branding	DIXON PREMVIN SUCTION
Reinforcement	Spring steel
Temperature	-10°C TO +55°C
Safety Factor	3:1

Sizes						
I.D (mm)	O.D (mm)	Max Working Pressure (Bar)	Min Burst Pressure (Bar)	Vacuum	Min Bend Radius (mm)	Weight (Kg/Mtr)
13	19	12	36	0.88	26	0.21
16	22	10.5	33	0.88	32	0.25
19	26	11	33	0.88	38	0.33
25	33	10	33	0.88	50	0.52
32	40	9	30	0.88	80	0.66
38	47	9	30	0.88	95	0.80
51	62	7	27	0.88	128	1.30
63	74	6	24	0.88	158	1.80
76	90	4	15	0.88	190	2.30
102	118	3	9	0.88	255	3.70
127	143	3	9	0.88	381	4.70
152	170	2.5	7	0.88	456	6.90

BESPOKE & SPECIALIST HYGIENIC HOSES AVAILABLE ON REQUEST TO SUIT SPECIFIC APPLICATIONS

All Hose Assemblies compliant with Pressure Equipment Directive 2014/68/EU

We reserve the right to change hose specifications without prior notice

BAKU - PVC Oil Suction & Delivery Hose



Technical Characteristics	
Application	Suitable for light fuel oils, diesels and kerosene for use in plants and tanker applications
Construction	Blue PVC according to EU10/2011
Branding	DIXON BAKU OIL HOSE
Reinforcement	PVC spiral helix
Temperature	-10°C TO +55°C
Safety Factor	3:1 and vacuum 0.88 bar to 0.78 depending on size

Sizes						
I.D (mm)	O.D (mm)	Max Working Pressure (Bar)	Min Burst Pressure (Bar)	Vacuum	Min Bend Radius (mm)	Weight (Kg/Mtr)
25	34	9.3	27.9	0.88	113	0.49
32	41	8	24	0.88	144	0.58
38	47	8	24	0.88	171	0.68
51	61	7.3	21.9	0.88	230	1.04
63	74	6.7	20.1	0.88	284	1.36
76	88	6	18	0.88	342	1.70
102	116	4.7	14.1	0.88	459	2.62
152	168	3.3	9.9	0.78	684	4.43

A104 - Dixon Red Multi-Purpose Non-Conductive OGS Hose



Technical Characteristics	
Application	Multi-Purpose hose for conveying a wide range of media inc. air, water, oil and other petroleum products used in steel mills, shipyards, foundries, auto plants and construction industries
Cover	Red smooth extruded, oil, abrasion, ozone and weather resistant NBR/SBR (Also available with black cover)
Branding	DIXON A104 Non Conductive Multipurpose 300 PSI WP SF 4:1 (Except *)
Reinforcement	High tensile strength textile plies
Lining	Black non-conductive NBR/SBR
Temperature	From -20°C to +100°C
Safety Factor	4:1

Sizes					
I.D (mm)	O.D (mm)	Max Working Pressure (Bar)	Min Burst Pressure (Bar)	Min Bend Radius (mm)	Weight (Kg/Mtr)
6	16	20	80	55	0.24
8	18	20	80	73	0.25
10	19	20	80	90	0.27
13	22	20	80	115	0.38
16	26	20	80	150	0.43
19	30	20	80	175	0.63
25	38	20	80	225	0.96
32	45	17*	68	320	1.24
38	53	17*	68	380	1.44
51	67	14*	56	500	1.50

All Hose Assemblies compliant with Pressure Equipment Directive 2014/68/EU

We reserve the right to change hose specifications without prior notice

A110 - Dixon Multi-Purpose Mineral Oil Hose 10 Bar



Technical Characteristics	
Application	Low pressure, electrically conductive fuel delivery hose for diesel, heating oils and petroleum including unleaded fuel for use across a variety of industries including automotive sector
Cover	Black smooth extruded, oil, abrasion, ozone and weather resistant NBR/SBR
Branding	DIXON LOGO, A110 MULTI-PURPOSE MINERAL OIL 10 BAR SF 4:1
Reinforcement	High tensile strength textile plies
Lining	Black non-conductive NBR
Temperature	From -40°C to +100°C
Safety Factor	4:1

Sizes					
I.D (mm)	O.D (mm)	Max Working Pressure (Bar)	Min Burst Pressure (Bar)	Min Bend Radius (mm)	Weight (Kg/Mtr)
5	12	10	40	40	0.10
6	12	10	40	45	0.15
8	14	10	40	55	0.12
10	17	10	40	60	0.17
13	20	10	40	80	0.24
16	24	10	40	100	0.33
19	28	10	40	120	0.43
25	35	10	40	150	0.62

A125 - Dixon Multi-Purpose Mineral Oil & Air Hose 25 Bar



Technical Characteristics	
Application	Medium pressure, electrically conductive fuel delivery hose for diesel, heating oils and petroleum including unleaded fuel for use across a variety of industries including automotive sector
Cover	Black smooth extruded, oil, abrasion, ozone and weather resistant NBR/SBR
Branding	DIXON LOGO, A125 MULTI-PURPOSE MINERAL OIL AIR 25 BAR 3:1
Reinforcement	High tensile strength textile plies
Lining	Black non-conductive NBR
Temperature	From -40°C to +80°C
Safety Factor	3:1

Sizes					
I.D (mm)	O.D (mm)	Max Working Pressure (Bar)	Min Burst Pressure (Bar)	Min Bend Radius (mm)	Weight (Kg/Mtr)
6	14	25	75	40	0.17
8	16	25	75	50	0.19
10	18	25	75	60	0.23
13	21	25	75	80	0.28
16	25	25	75	100	0.38
19	29	25	75	120	0.50
25	36	25	75	150	0.73

All Hose Assemblies compliant with Pressure Equipment Directive 2014/68/EU

We reserve the right to change hose specifications without prior notice

A420 - Dixon Tanker Reeling Hose 17 Bar



Technical Characteristics	
Application	Petroleum tanker delivery hose specifically designed for use on reels. Suitable for oil, diesel, domestic fuels and petrol including unleaded
Cover	Red smooth extruded, oil, abrasion, ozone and weather resistant
Branding	DIXON A420 TANKER REELING HOSE 17 BAR
Reinforcement	2 x high strength textile yarn, 2 x copper braided anti-static wires
Lining	Black smooth NBR, suitable for diesel, domestic fuels including unleaded petrol
Temperature	-20°C to +70°C
Safety Factor	3:1

Sizes					
I.D (mm)	O.D (mm)	Max Working Pressure (Bar)	Min Burst Pressure (Bar)	Min Bend Radius (mm)	Weight (Kg/Mtr)
35	49	17	51	210	1.40
38	52	17	51	230	1.60

A430 - Dixon Oil Suction & Delivery Hose 10 Bar



Technical Characteristics	
Application	Used in petrochemical plants and dockyards for handling unleaded fuels and hydraulic oils
Cover	Black mandrel wrap, oil, abrasion, ozone and weather resistant CR/NBR
Branding	DIXON LOGO, A430 OIL S & D 10BAR / 0.93 VAC SF 3:1
Reinforcement	High tensile strength textile plies, twin steel helix and anti-static wires
Lining	Black oil resistant NBR suitable for 50% aromatic hydrocarbons
Temperature	From -35°C to +80°C
Safety Factor	3:1

Sizes					
I.D (mm)	O.D (mm)	Max Working Pressure (Bar)	Min Burst Pressure (Bar)	Min Bend Radius (mm)	Weight (Kg/Mtr)
25	35	10	30	178	0.70
32	42	10	30	224	0.80
38	47	10	30	266	0.90
51	62	10	30	357	1.60
63	74	10	30	441	1.90
76	88	10	30	530	2.50
102	114	10	30	714	3.80
152	172	10	30	1064	9.50

All Hose Assemblies compliant with Pressure Equipment Directive 2014/68/EU

We reserve the right to change hose specifications without prior notice

A460 - Dixon Oil Suction & Delivery Hose 20 Bar



Technical Characteristics	
Application	Heavy duty hose used in petrochemical plants and dockyards for handling unleaded fuels and hydraulic oils
Cover	Black mandrel wrap, oil, abrasion, ozone and weather resistant CR
Branding	DIXON LOGO A460 OIL S&D 20 BAR SF 3:1 VAC 0.9 BAR
Reinforcement	High tensile strength textile plies, twin steel helix and anti-static wires
Lining	Black oil resistant NBR suitable for 50% aromatic hydrocarbons
Temperature	From -40°C to +100°C
Safety Factor	3:1

Sizes					
I.D (mm)	O.D (mm)	Max Working Pressure (Bar)	Min Burst Pressure (Bar)	Min Bend Radius (mm)	Weight (Kg/Mtr)
51	65	20	60	255	2.08
76	93	20	60	375	3.72
102	123	20	60	510	6.10
152	176	20	60	760	11.02

A400EU - Dixon Oil, Mud & Sea Water Suction & Delivery Hose 20 Bar



Technical Characteristics	
Application	Extra heavy duty hose for arduous applications including tanker loading and unloading, offshore and onshore and petrochemical plants
Cover	Black mandrel wrap, hydrocarbon, mud, sea water, abrasion, ozone and weather resistant CR
Branding	DIXON LOGO, BULKSTREAM A400EU OIL MUD SEA WATER S & D 20 BAR S:F 4:1 VAC 0.9 BAR
Reinforcement	Multi layer high tensile strength textile plies, steel helix wire and antistatic wires
Lining	Black oil, mud, sea water resistant NBR suitable for 50% aromatic hydrocarbons
Temperature	From -30°C to +90°C.
Safety Factor	4:1

Sizes					
I.D (mm)	O.D (mm)	Max Working Pressure (Bar)	Min Burst Pressure (Bar)	Min Bend Radius (mm)	Weight (Kg/Mtr)
76	94	20	80	380	3.90
102	126	20	80	510	6.90
152	181	20	80	760	12.80
203	235	20	80	1220	19.30

All Hose Assemblies compliant with Pressure Equipment Directive 2014/68/EU

We reserve the right to change hose specifications without prior notice

A410 - Dixon UHMWPE Chemical Suction & Delivery Hose 10 Bar



Technical Characteristics	
Application	Used for a wide range of chemicals including acids and alkalines within plants and on road tankers
Cover	Blue EPDM rubber ozone and weather resistant
Branding	DIXON LOGO, A410 Chemical S&D UHMWPE
Reinforcement	High tensile strength textile ply, twin carbon steel wire helix, copper braided anti-static wire
Lining	Ultra High Molecular Weight Polyethylene
Temperature	From -30°C to +100°C (Subject to chemical compatibility), +130°C for intermittent sterilization
Safety Factor	4:1

Sizes

I.D (mm)	O.D (mm)	Max Working Pressure (Bar)	Min Burst Pressure (Bar)	Min Bend Radius (mm)	Weight (Kg/Mtr)
19	31	10	40	125	0.68
25	37	10	40	150	0.85
32	44	10	40	175	1.05
38	51	10	40	225	1.20
51	66	10	40	275	1.78
63	77	10	40	300	2.50
76	92	10	40	350	2.95
102	120	10	40	450	4.11

A416 - Dixon UHMWPE Chemical Suction & Delivery Hose 16 Bar

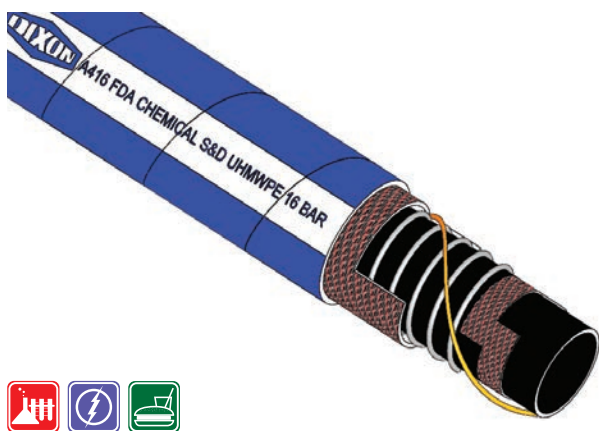

Technical Characteristics	
Application	FDA approved hose used for a wide range of chemicals including acids and alkaline within plants, on road tankers and water utility industries
Cover	Blue EPDM rubber ozone and weather resistant
Branding	DIXON LOGO, A416 FDA Chemical S&D UHMWPE
Reinforcement	High tensile strength textile ply, twin carbon steel wire helix, copper braided anti-static wire
Lining	Food Quality (FDA Specification) conductive Ultra High Molecular Weight Polyethylene
Temperature	From -30°C to +100°C (Subject to chemical compatibility), +130°C for intermittent sterilization
Safety Factor	3:1

Sizes

I.D (mm)	O.D (mm)	Max Working Pressure (Bar)	Min Burst Pressure (Bar)	Min Bend Radius (mm)	Weight (Kg/Mtr)
19	31	16	48	125	0.68
25	37	16	48	150	0.85
32	44	16	48	175	1.05
38	51	16	48	225	1.20
51	66	16	48	275	1.78
63	77	16	48	300	2.50
76	92	16	48	350	2.95
102	120	16	48	450	4.11

All Hose Assemblies compliant with Pressure Equipment Directive 2014/68/EU

We reserve the right to change hose specifications without prior notice

A901GG - Dixon Oil Composite Hose 14 Bar



Technical Characteristics	
Application	Highly flexible oil transfer hose for use on road tankers, petrochemical refinery and environmental service applications
Cover	Black weatherproof UV, ozone and abrasion resistant PVC and galvanised carbon steel external wire
Branding	DIXON LOGO DIXOIL TYPE 3 EN13765:2015 14 BAR 80°C
Reinforcement/ Lining	Galvanised carbon steel internal wire, polypropylene, polyethylene & polyester films and polypropylene fabrics
Electrical Resistance	>10 Ohms per metre according to BS5842
Temperature	-30°C TO +80°C
Safety Factor	4:1

Sizes				
Nominal Bore (mm)	Max Working Pressure (Bar)	Min Burst Pressure (Bar)	Min Bend Radius (mm)	Weight (Kg/Mtr)
25	14	56	75	0.80
32	14	56	80	1.00
40	14	56	85	1.40
50	14	56	125	2.00
65	14	56	150	2.80
75	14	56	175	3.50
100	14	56	250	4.80

A901AG - Dixon Vapour Recovery Composite Hose 14 Bar

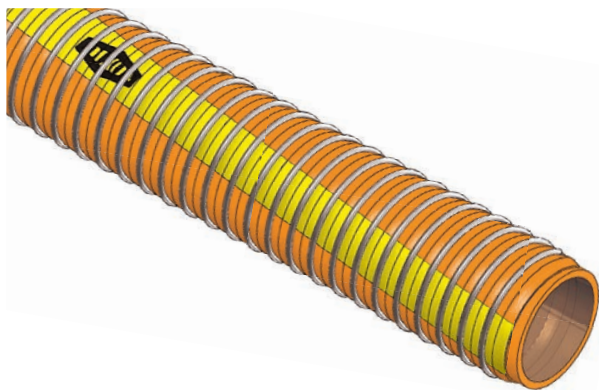

Technical Characteristics	
Application	Highly flexible VRH oil composite hose for use on petrol forecourts and petrochemical refineries
Cover	Orange weatherproof UV, ozone and abrasion resistant PVC and galvanised carbon steel external wire
Branding	DIXON LOGO DIXOIL TYPE 3 EN13765:2015 14 BAR 80°C
Reinforcement/ Lining	Aluminium internal wire, with polypropylene, polyethylene films and fabrics
Electrical Resistance	>10 Ohms per metre according to BS5842
Temperature	-30°C TO +80°C
Safety Factor	4:1

Sizes				
Nominal Bore (mm)	Max Working Pressure (Bar)	Min Burst Pressure (Bar)	Min Bend Radius (mm)	Weight (Kg/Mtr)
75	14	56	185	2.10
100	14	56	275	2.90

All Hose Assemblies compliant with Pressure Equipment Directive 2014/68/EU

We reserve the right to change hose specifications without prior notice

A906PG - Dixon Chemical Composite Hose 14 Bar



Technical Characteristics	
Application	Highly flexible hose for petrochemical plants and road tankers
Cover	Grey weatherproof UV, ozone and abrasion resistant PVC and galvanised carbon steel external wire
Branding	DIXON LOGO DIXCHEM TYPE 3 EN13765:2015 14 BAR 80°C
Reinforcement/ Lining	Polypropylene coated galvanised carbon steel internal wire with polypropylene, polyethylene films and fabrics
Electrical Resistance	>10 Ohms per metre according to BS5842
Temperature	-30°C TO +80°C
Safety Factor	4:1

Please Note: Stainless inner and outer wire option available upon request (A906PS)

Sizes				
Nominal Bore (mm)	Max Working Pressure (Bar)	Min Burst Pressure (Bar)	Min Bend Radius (mm)	Weight (Kg/Mtr)
25	14	56	75	0.80
32	14	56	80	1.00
40	14	56	85	1.40
50	14	56	125	2.00
65	14	56	150	2.80
75	14	56	175	3.50
100	14	56	250	4.80

A911SG - Dixon PTFE Chemical Composite Hose 14 Bar



Technical Characteristics	
Application	PTFE lined hose designed for use on plant and road tankers with a wide range of aggressive chemicals or foods
Cover	Red weatherproof UV, ozone and abrasion resistant PVC and galvanised carbon steel external wire
Branding	DIXON LOGO PTFE TYPE 3 EN13765:2015 14 BAR 120°C
Reinforcement / Lining	Stainless steel internal wire, PTFE lined with polypropylene, polyethylene films and fabrics
Electrical Resistance	>10 Ohms per metre according to BS5842
Temperature	-30°C TO +120°C
Safety Factor	4:1

Please Note: Stainless inner and outer wire option available upon request (A911SS)

Sizes				
Nominal Bore (mm)	Max Working Pressure (Bar)	Min Burst Pressure (Bar)	Min Bend Radius (mm)	Weight (Kg/Mtr)
25	14	56	75	0.80
32	14	56	80	1.00
40	14	56	85	1.40
50	14	56	125	2.00
65	14	56	150	2.80
75	14	56	175	3.50
100	14	56	250	4.80

All Hose Assemblies compliant with Pressure Equipment Directive 2014/68/EU

We reserve the right to change hose specifications without prior notice

A230 - Dixon High Pressure Red Saturated Steam Hose 18 Bar



Technical Characteristics	
Application	High pressure saturated steam hose for high temperatures. Used in petrochemical plants/ refineries for maintenance and pipe insulation
Cover	Red mandrel wrap, ozone and weather resistant pin pricked EPDM. (Also available in black)
Branding	DIXON LOGO, A230 SUPER STEAM 18 BAR - SF 10:1 BS5342 A2 1985 (Black Stripe)
Reinforcement	2 ply multi stranded high tensile strength steel wires
Lining	Black EPDM
Temperature	From -40°C to +210°C. Intermittent 232°C
Safety Factor	10:1

Sizes					
I.D (mm)	O.D (mm)	Max Working Pressure (Bar)	Min Burst Pressure (Bar)	Min Bend Radius (mm)	Weight (Kg/Mtr)
13	25	18	180	130	0.53
19	32	18	180	190	0.76
25	38	18	180	250	1.00
32	46	18	180	320	1.30
38	54	18	180	380	1.65
51	67	18	180	500	2.20

A235BK - Dixon Black Saturated Steam Hose 7 Bar



Technical Characteristics	
Application	Saturated steam hose for high temperatures. Used in petrochemical plants/refineries for maintenance and pipe insulation
Cover	Black mandrel wrap, ozone and weather resistant pin pricked EPDM
Branding	DIXON LOGO, A235 Saturated Steam 7 BAR SF 10:1 170 deg C BS5122 A2
Reinforcement	High tensile strength textile plies
Lining	Black EPDM
Temperature	From -20°C to +170°C
Safety Factor	10:1

Sizes					
I.D (mm)	O.D (mm)	Max Working Pressure (Bar)	Min Burst Pressure (Bar)	Min Bend Radius (mm)	Weight (Kg/Mtr)
13	25	7	70	91	0.40
19	32	7	70	133	0.60
25	40	7	70	175	0.80

STEAM IS DANGEROUS. WE STRONGLY RECOMMEND THE USE OF GENUINE DIXON BOSS STEAM COUPLINGS AND CLAMPS. ONLY HOSE FITTINGS, CLAMPS AND ACCESSORIES APPROVED FOR STEAM SERVICE SHOULD BE USED.

All Hose Assemblies compliant with Pressure Equipment Directive 2014/68/EU

We reserve the right to change hose specifications without prior notice

A235BU - Dixon Steam, Hot Water & Food Hose 7 Bar

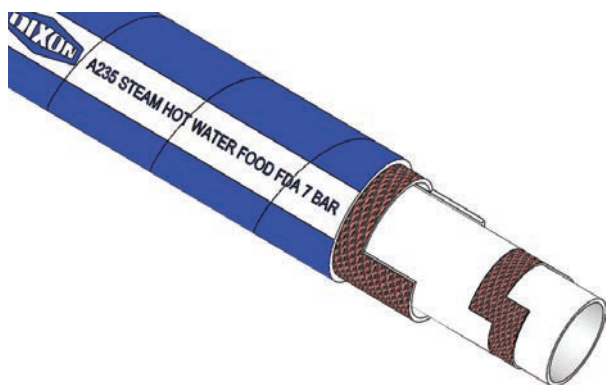

Technical Characteristics	
Application	Multi-purpose steam, hot water and food hose. Used in food & beverage industry
Cover	Blue mandrel wrap, ozone and weather resistant pin pricked EPDM
Branding	DIXON LOGO, A235 STEAM HOT WATER FOOD FDA 7 BAR
Reinforcement	High tensile strength textile plies
Lining	White food grade EPDM rubber FDA approved compounds
Temperature	From -20°C to +170°C (STEAM) +95°C (HOT WATER)
Safety Factor	10:1

Sizes					
I.D (mm)	O.D (mm)	Max Working Pressure (Bar)	Min Burst Pressure (Bar)	Min Bend Radius (mm)	Weight (Kg/Mtr)
13	24	7	70	91	0.40
16	28	7	70	112	0.50
19	32	7	70	133	0.60
25	39	7	70	175	0.80

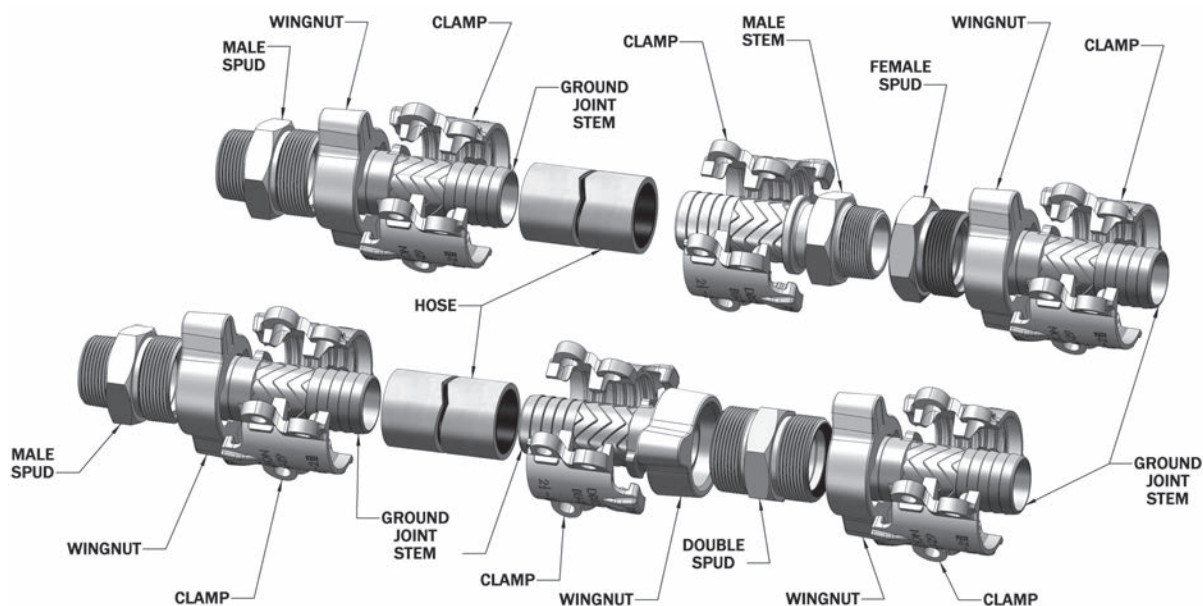

STEAM IS DANGEROUS. WE STRONGLY RECOMMEND THE USE OF GENUINE DIXON BOSS STEAM COUPLINGS AND CLAMPS. ONLY HOSE FITTINGS, CLAMPS AND ACCESSORIES APPROVED FOR STEAM SERVICE SHOULD BE USED.

All Hose Assemblies compliant with Pressure Equipment Directive 2014/68/EU

We reserve the right to change hose specifications without prior notice



A361 - Dixon Bulk Material Suction & Delivery Hose 10 bar



Technical Characteristics	
Application	Heavy duty hose for use in mining, construction, civil engineering, foundries and bulk transportation
Cover	Black abrasion, weather & ozone resistant synthetic rubber
Branding	DIXON LOGO, A361 BULK MATERIAL S & D HOSE 10 BAR
Reinforcement	High tensile strength textile plies, steel helix and anti-static wires
Lining	Black anti-static natural rubber
Temperature	From -40°C to +70°C
Safety Factor	3:1

Sizes					
I.D (mm)	O.D (mm)	Max Working Pressure (Bar)	Min Burst Pressure (Bar)	Min Bend Radius (mm)	Weight (Kg/Mtr)
76	92	10	30	380	3.76
102	120	10	30	550	4.55

PREMFLEX - MDSE Chemical & Abrasion PVC Suction & Delivery Hose

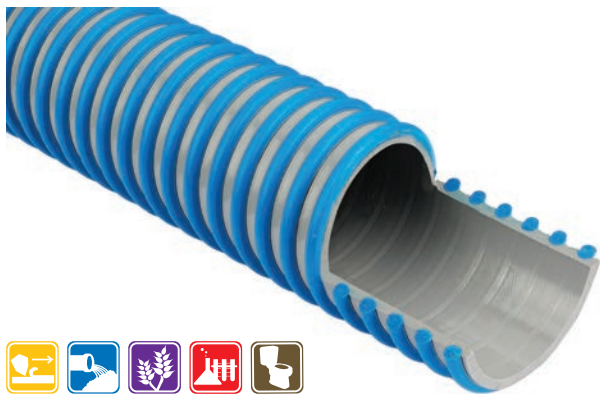

Technical Characteristics	
Application	Suitable for most suction and delivery applications for conveying chemical solutions, abrasive slurries and solids
Construction	Grey PVC according to EU10/2011
Branding	DIXON PREMFLEX
Reinforcement	PVC spiral helix
Temperature	-10°C TO +55°C
Safety Factor	3:1

Sizes						
I.D (mm)	O.D (mm)	Max Working Pressure (Bar)	Min Burst Pressure (Bar)	Vacuum	Min Bend Radius (mm)	Weight (Kg/Mtr)
38	49	5.3	16	0.9	152	0.70
51	65	5	15	0.9	204	1.05
63	76	4.7	14	0.9	252	1.39
76	92	4.3	13	0.9	304	1.70
102	120	4	12	0.9	408	2.70
127	145	3.3	10	0.9	508	3.90
152	171	3.3	10	0.9	608	5.00

All Hose Assemblies compliant with Pressure Equipment Directive 2014/68/EU

We reserve the right to change hose specifications without prior notice

Metallic Hose

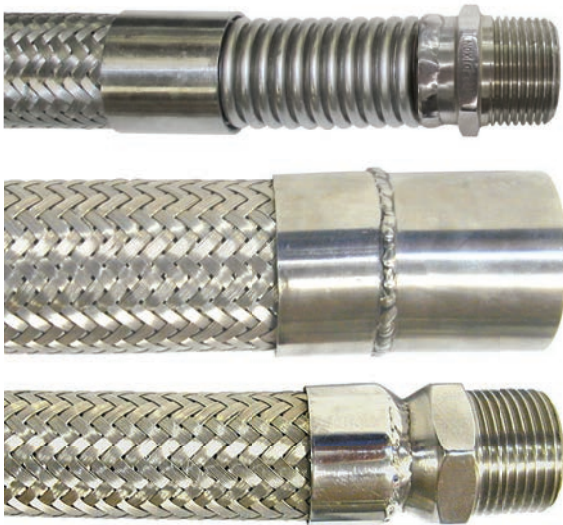

Technical Characteristics	
Application	Versatile robust hose suited to high pressure, high temperature and corrosive applications, flexible metal hoses can accommodate angular movements, temperature expansion, vibration and misalignment. Dixon offers a variety of metallic hose options suited to individual applications including steam, compressed air, petrochemical and vacuum
Description	Corrugated flexible metal hose assembly meeting the requirements of class 1 of the EN ISO 10380 standard
Hose Material	AISI 316L or AISI 321 stainless steel & exotics
Braid Material	AISI 304
Bore Size Range	6mm to 300mm
Temperature Range	-200°C to 650°C
Available Options	<ul style="list-style-type: none"> • Convoluted Core Only • Single, Double or Triple Braid • HP & THP High Pressure • A range of standard and close pitch constructions • Radiograph, NDT or Dyepen

Adflex Commercial Grade Metallic Hose						
Nominal I.D	Maximum O.D (mm)		Dynamic Bend Radius (mm)	Static Bend Radius (mm)	Max Working Pressure (Bar)	
	Without Braid	With Braid			No Braid	Single Braid
DN 6	12.2	13.4	100	25	4	100
DN 10	15.8	17.0	150	40	4	90
DN 12	17.5	18.7	200	50	3	80
DN 15	22	23.2	200	50	2	64
DN 20	26.3	27.5	200	70	2	64
DN 25	33.8	35.3	200	90	2.0	50
DN 32	42	43.6	250	110	1.5	40
DN 40	51.6	53.2	250	130	1.5	30
DN 50	61.7	63.3	350	175	1.0	28
DN 65	77	79.0	410	200	1.0	24
DN 80	91	93.0	450	205	1.0	18
DN 100	117.5	119.5	560	230	0.8	16
DN 125	149	151	660	280	0.6	12
DN 150	178	180	815	320	0.6	10
DN 200	228	230.4	1015	435	0.5	8
DN 250	278	280.4	1220	560	0.5	6
DN 300	333	335.8	1420	660	0.3	5
DN 300	336	339	1525	725	0.1	6

Note: Dimension tolerances meeting the requirements of class 1 of the EN ISO 10380 standard applies. De-rating factors will apply for elevated temperature applications, refer to the technical section or call Dixon for further information.

All Hose Assemblies compliant with Pressure Equipment Directive 2014/68/EU

We reserve the right to change hose specifications without prior notice

Metallic Hose (continued)

Suparflex Standard Pitch Metallic Hose												
Nominal I.D	Maximum O.D (mm)			Dynamic Bend Radius (mm)			Static Bend Radius (mm)			Max Working Pressure (Bar)		
	Single Braid	Double Braid	Triple Braid	Single Braid	Double Braid	Triple Braid	Single Braid	Double Braid	Triple Braid	Single Braid	Double Braid	Triple Braid
DN 6	9.8	11.4	13	-	110	140	10	23	25	18	140	145
DN 8	13.6	15.2	16.8	-	130	130	14	28	32	14	115	121
DN 10	16.2	17.8	19.4	-	150	150	16	32	38	10	90	105
DN 12	18.6	17.8	19.4	-	165	165	24	39	45	12	80	97
DN 15	22.5	24.1	25.7	-	195	195	29	50	58	7.5	63	77
DN 20	28.3	29.9	31.5	-	225	225	35	60	70	4.3	50	68
DN 25	34.8	36.4	38	-	260	260	42	73	85	3	40	55
DN 32	43.3	45.4	47.4	-	300	300	51	90	105	3.3	40	55
DN 40	52.4	54.4	56.4	-	340	340	61	115	130	2.2	32	44
DN 50	64.8	67.3	69.8	-	390	390	73	140	160	2.1	32	45
DN 65	80.9	83.4	85.9	-	460	460	89	175	200	1.3	25	38
DN 80	99.6	102.6	105.6	-	660	660	108	240	240	1.4	23	38
DN 100	126.5	129.5	132.5	-	750	750	126	290	290	0.5	15	25
DN 125	152	155	-	-	1000	-	147	340	-	0.4	13	-
DN 150	174	177	-	-	1250	-	169	390	-	0.3	11	-

Note: Dimension tolerances meeting the requirements of class 1 of the EN ISO 10380 standard applies. De-rating factors will apply for elevated temperature applications, refer to the technical section or call Dixon for further information.

Hyparflex Close Pitch Metallic Hose												
Nominal I.D	Maximum O.D (mm)			Dynamic Bend Radius (mm)			Static Bend Radius (mm)			Max Working Pressure (Bar)		
	Single Braid	Double Braid	Triple Braid	Single Braid	Double Braid	Triple Braid	Single Braid	Double Braid	Triple Braid	Single Braid	Double Braid	Triple Braid
DN 6	9.8	11.4	13	-	110	140	9	20	25	18	150	175
DN 8	13.6	15.2	16.8	-	130	130	12	20	32	9	115	158
DN 10	16.2	17.8	19.4	-	150	150	14	20	38	6	115	135
DN 12	18.6	20.2	21.8	-	124	124	21	25	45	6	80	125
DN 15	22.5	24.1	25.7	-	164	164	26	32	58	3	63	97
DN 20	28.3	29.9	31.5	-	169	169	32	38	70	2.2	55	77
DN 25	34.8	36.4	38	-	195	195	37	45	85	1.8	40	62
DN 32	43.4	45.4	47.4	-	225	225	46	58	105	1.6	40	58
DN 40	52.4	54.4	56.4	-	255	255	55	70	113	1.2	32	44
DN 50	64.8	67.3	69.8	-	293	293	65	85	136	1	32	47
DN 65	80.9	83.4	85.9	-	345	345	80	105	171	0.5	25	41
DN 80	99.6	102.6	105.6	-	495	495	97	180	224	0.7	23	40
DN 100	126.5	129.5	132.5	-	563	563	113	218	276	0.4	15	27
DN 125	152	155	-	-	1000	-	132	255	-	0.25	13	-
DN 150	174	177	-	-	1250	-	152	290	-	0.2	11	-

Note: Dimension tolerances meeting the requirements of class 1 of the EN ISO 10380 standard applies. De-rating factors will apply for elevated temperature applications, refer to the technical section or call Dixon for further information.

All Hose Assemblies compliant with Pressure Equipment Directive 2014/68/EU

We reserve the right to change hose specifications without prior notice

HP/THP High Pressure Metallic Hose						
Nominal I.D	Maximum O.d (Mm)		Dynamic Bend Radius (mm)	Static Bend Radius (mm)	Max Working Pressure (Bar)	
	Single Braid	Double Braid			Single Braid	Double Braid
DN 6	11.4	13	110	25	180	255
DN 10	17.8	19.4	150	38	145	195
DN 12	20.2	21.8	165	45	140	185
DN 20	29.1	30.7	225	70	85	125
DN 25	38	40	215/ 260	85	78	124
DN 32	46.5	49	300	105	65	115
DN 40	54.9	57.4	280/ 340	130	61	90
DN 50	67.3	69.8	390	160	55	78
DN 65	83.9	86.9	460	200	52	75
DN 80	99	102	660	240	25	50
DN 100	129.5	132.5	750	290	24	45
DN 125	155	158	1000	350	20	38
DN 150	185	188	1250/ 1550	400	27	34
DN 200	246	253.5	1600/ 2000	520	27	30

Note: Dimension tolerances meeting the requirements of class 1 of the EN ISO 10380 standard applies. De-rating factors will apply for elevated temperature applications, refer to the technical section or call Dixon for further information.

All Hose Assemblies compliant with Pressure Equipment Directive 2014/68/EU

We reserve the right to change hose specifications without prior notice



Telephone: +44 (0)1772 323529

Email: sales@dixoneurope.co.uk

PTFE Hose

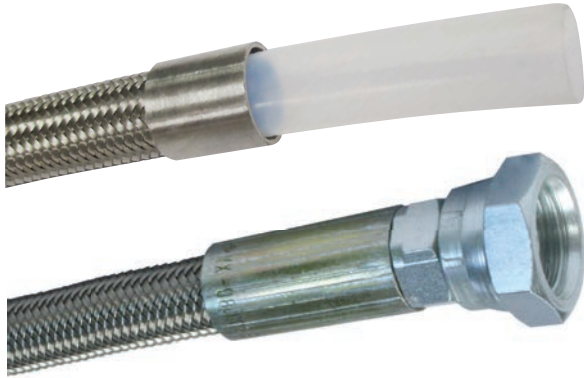

Technical Characteristics	
Application	Inert to practically all commercial chemicals, acids, solvents and hydraulic fluids, these assemblies absorb no moisture and have low volumetric expansion. Easy to clean and sterilise. Particularly suited to arduous flexing over an extended temperature range. Pharmaceutical and food processing industries - does not contaminate the media being passed through the hose. Tasteless and odourless
Available Options	<ul style="list-style-type: none"> • Bounce Ring Protectors and Spiral Guards • Specialist requirements such as heat traced and duplex assemblies • Antistatic liners are available for when electrically resistive fluids are being transferred at high flow rates

Smoothbore - Stainless Steel Braid



Technical Characteristics	
PTFE Material	FDA approved smooth bore
Braid Material	AISI 304 or AISI 316
Size Range	6mm to 25mm
Temperature Range	-60°C to 260°C

Smoothbore PTFE Hose c/w Stainless Steel Braid						
Size (inch)	Tube Wall Thickness (mm)	Braid OD (mm)	Tolerance +/- (mm)	Max. Working Pressure (Bar)	Min. Burst Pressure (Bar)	Min Bend Radius (mm)
1/4	0.64	8.64	0.60	241	724	76
3/8	0.64	13.21	0.60	219	655	127
1/2	0.76	15.40	0.60	161	483	140
5/8	0.89	18.40	0.75	138	414	165
3/4	0.89	22.10	0.85	114	345	203
1	1.10	29.75	1.20	69	207	305

All Hose Assemblies compliant with Pressure Equipment Directive 2014/68/EU

We reserve the right to change hose specifications without prior notice

Convuluted & Anti-Static – Stainless Steel Braid



Technical Characteristics	
PTFE Material	FDA approved black/white virgin convoluted or black anti-static convoluted
Braid Material	AISI 304, AISI 316 or synthetic polymer
Available Options	<ul style="list-style-type: none"> • Bounce Ring Protectors and Spiral Guards • Specialist requirements such as heat traced and duplex assemblies. • Antistatic liners are available for when electrically resistive fluids are being transferred at high flow rates.
Size Range	10mm to 100mm
Temperature Range	-60°C to 260°C

Convuluted & Anti-Static PTFE Hose c/w External Vacuum Wire and Stainless Steel Braid										
Size (in)	Braid ID (mm)		Wall Thickness (mm)	Braid OD (mm)		Bend Radius (mm)	Max. Working Pressure	Min. Burst Pressure	Vacuum (mbar) 20C	Weight (gr/m)
	(min)	(max)		(min)	(max)					
¼	5.5	6.9	0.76	11.4	13.3	25	35	170	744	150
⅜	8.5	10.5	0.76	14.7	16.5	25	35	170	744	203
½	11.6	13.6	0.89	17.9	20	25	50	250	947	220
⅝	15.1	16.4	0.89	24.7	25.8	35	35	170	947	320
¾	19.5	20.5	1	28.6	31.4	55	60	290	947	540
1	24.5	25.5	1.1	34.2	38.2	85	40	210	947	890
1¼	31.5	32.5	1.15	41.9	46.1	100	45	210	947	1180
1½	36.5	37.5	1.45	47.2	49.9	120	40	175	947	1710
1¾	44.5	45.5	1.45	55.8	61.4	135	25	135	947	2450
2	49.5	50.5	1.5	60.5	66.7	165	25	135	947	2610
2½	62.5	63.5	1.6	80.9	89.1	230	14	60	947	3440
3	73.5	74.5	1.6	90.4	99.6	260	12	65	947	4710
4	94.5	99.5	1.82	121.1	127.5	400	10	40	947	5550

All Hose Assemblies compliant with Pressure Equipment Directive 2014/68/EU

We reserve the right to change hose specifications without prior notice

Convoluted & Anti-Static – Polymer Braid



Technical Characteristics	
PTFE Material	FDA approved black/white virgin convoluted or black anti-static convoluted
Braid Material	Synthetic polypropylene yarn braid (Blue or Black)
Size Range	20mm to 100mm
Temperature Range	-30°C to 95°C

Convoluted & Anti-Static PTFE Hose c/w External Vacuum Wire and Polypropylene Braid										
Size (in)	Braid ID (mm)		Wall Thickness (mm)	Braid OD (mm)		Bend Radius (mm)	Max. Working Pressure	Min. Burst Pressure	Vacuum (mbar) 20C	Weight (gr/m)
	(min)	(max)		(min)	(max)					
¼	11.6	13.6	0.89	21.4	23.4	50	10	40	947	210
⅝	15.1	16.4	0.89	26.3	28.2	65	10	40	947	400
¾	19.5	20.5	1	31.1	33.9	55	10	40	947	490
1	24.5	25.5	1.1	36.7	40.7	85	10	40	947	810
1¼	31.5	32.5	1.15	44.4	48.6	100	10	40	947	1070
1½	36.5	37.5	1.45	49.7	52.4	120	10	40	947	1310
1¾	44.5	45.5	1.45	58.3	63.9	135	10	40	947	1850
2	49.5	50.5	1.5	62.5	69.2	165	10	40	947	2050
2½	62.5	63.5	1.6	83.4	91.6	230	10	40	947	3440
3	73.5	74.5	1.6	92.9	102.2	260	10	40	947	3920

All Hose Assemblies compliant with Pressure Equipment Directive 2014/68/EU

We reserve the right to change hose specifications without prior notice

Metallic & PTFE Assemblies – Standard End Configurations

Metallic and PTFE hose assemblies are available in a wide variety of end configurations in common materials including stainless steel, aluminium and mild steel.

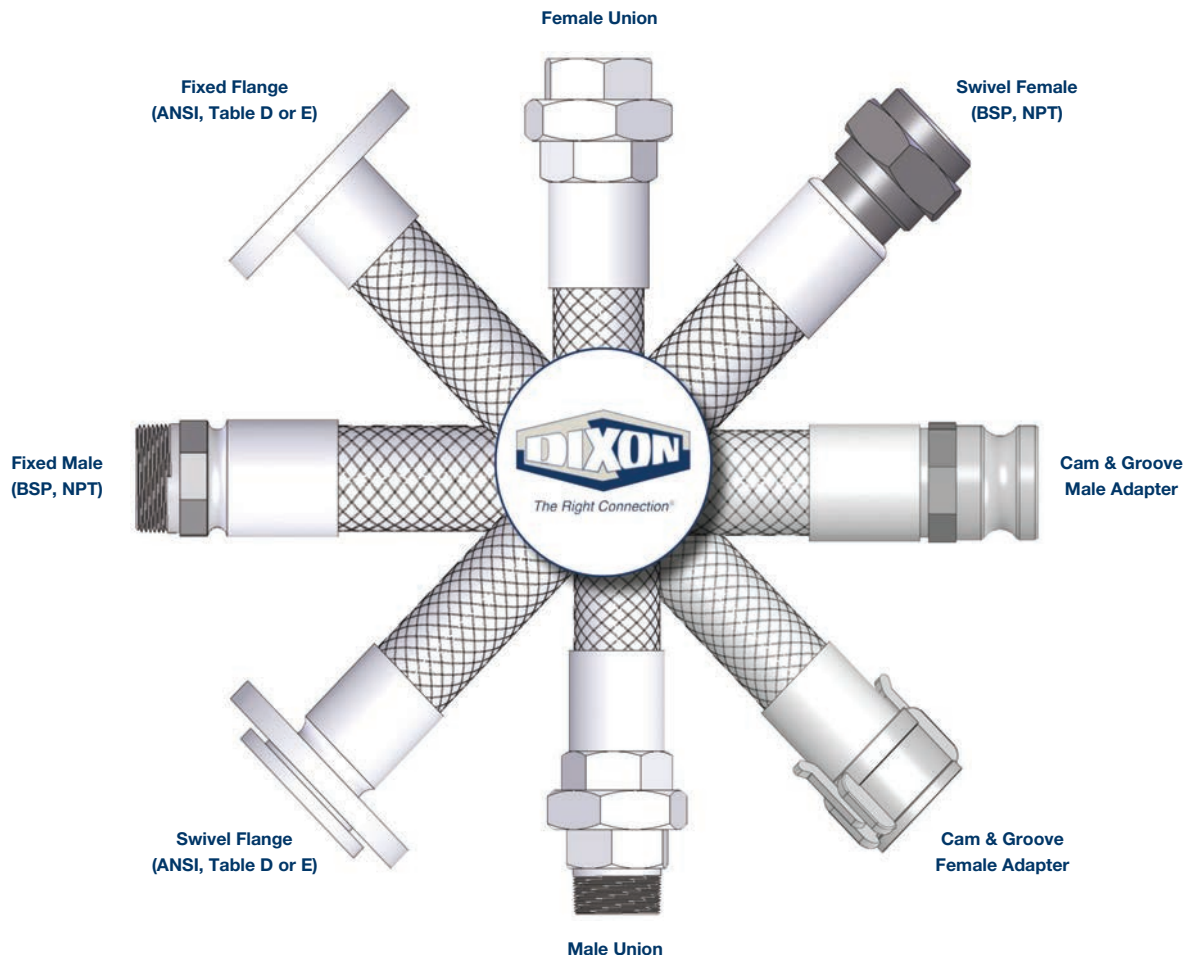

Hoses Assemblies manufactured as an assembly to customer specification. Larger sizes available on request. All hoses are tested 150 p.s.i air under water and can be supplied with a wide range of certification if required.

All Hose Assemblies compliant with Pressure Equipment Directive 2014/68/EU

We reserve the right to change hose specifications without prior notice

Bulkstream



Technical Characteristics	
Description	This special range of Dixon hoses are often referred to as hand-built hoses Assemblies with either built in or crimped ends Built to bespoke customers' requirements, according to application
Hose Material	Rubber Compound (liner)
Braid Material	Smooth or corrugated cover
Bore Size Range	51mm to 1000mm
Length	Various (NB: maximum length is determined by mandrel length of the relevant bore size)
Working Pressure	3.5 bar to 40 bar
Vacuum	0.9 bar
Temperature Range	-30°C to +150°C (depending on application & rubber liner compound)
Hose Standards	<ul style="list-style-type: none"> • BS EN 1765 for ship to shore or ship to ship • EN 12115 for chemical • Lloyds Approval standard hoses are available • Others upon request



Material & Application	
Rubber compound (liner)	Typical Applications
NBR (Nitrile Butadiene Rubber)	Fuels: • Oils • Diesel • Mud & others
EPDM (Ethylene Propylene Diene Monomer)	Chemicals: • Sea water • Hot Water & others
NR (Natural Rubber)	Dry powders: • Sand • Animal feed & abrasives
SBR (Styrene Butadiene Rubber)	• Air • Water

Additional rubber compounds available include: CSM (Hypalon), FPM (Viton), CR (Chlorobutyl).

Heat Traced /Jacketed Hose

Metallic & Industrial hoses can be provided with an electric heat trace cabling to facilitate heating of the hose body ensuring continuous flow of product. This can be supplied and terminated with an electrical junction box at one hose end.

Hoses can be designed and engineered to bespoke requirements including heat shrink and jacketed covers. Heated/jacketed hoses can also be provided using hot water or steam.



All Hose Assemblies compliant with Pressure Equipment Directive 2014/68/EU

We reserve the right to change hose specifications without prior notice

GSM Ball Joint Armoured Hose

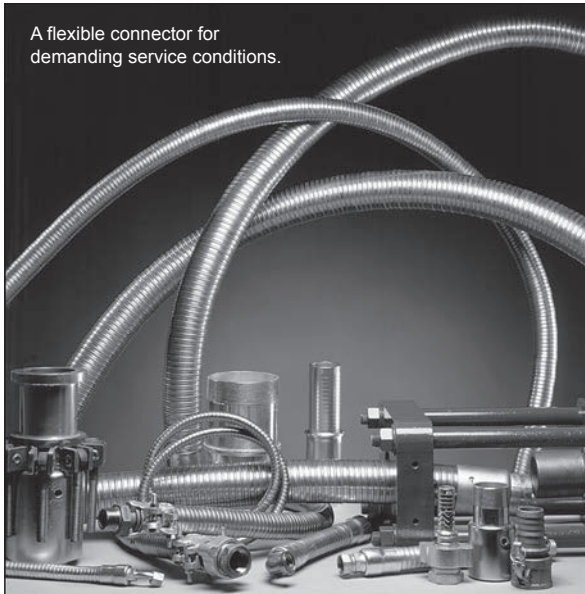

A flexible connector for demanding service conditions.

Technical Characteristics	
Features	<ul style="list-style-type: none"> • Resists kinking • Superior flexibility • Resists external heat • Protects against abrasion • Provides longer life • Works with many types of end fittings • Suitable for low and high pressure conditions, including high pressure hydraulic use • Armour available in galvanised steel and stainless steel • Cost effective



GSM Ball-Joint Armour protects against extreme heat, abrasion and kinking. Available in stainless steel or galvanised steel.

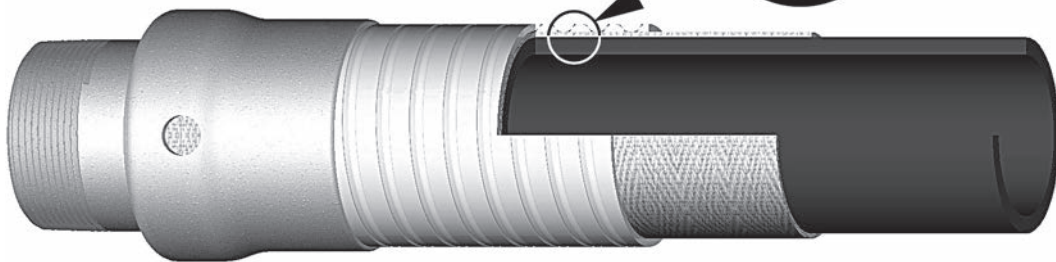

Armour enlargement. No interlocking parts to restrict bending.

Various layers of fibreglass insulation can be applied to resist extreme heat.

Inner hose supplied is designed for material conveyed. (Hose can be rubber, PTFE or metal).

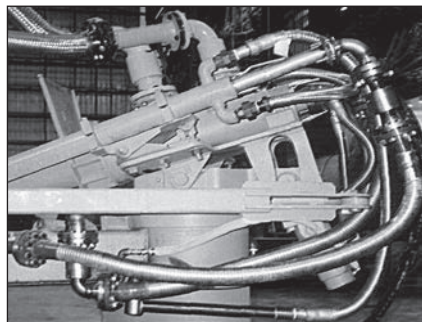

GSM Water, Oxygen and Gas Hoses handling critical Steel Mill applications.

All Hose Assemblies compliant with Pressure Equipment Directive 2014/68/EU

We reserve the right to change hose specifications without prior notice

Hose Fittings and Accessories

Hose & Coupling Solutions

Dixon are a leading manufacturer and supplier of an immense array of hose and coupling products utilised across a wide range of industries.

Our vast product range includes many differing options to complement the hose offering whether used to make hose assemblies in-house or on plant, tankers and machinery. From standard crimped couplings to genuine Boss steam fittings.

For further information on any of couplings, fittings and valves below please do not hesitate to contact our sales office or visit us online at www.dixoneurope.co.uk



AIR FITTINGS & ACCESSORIES



Air Receiver Manifold, "Air King" Universal Couplings & Clamps, European Compressor Couplings & Clamps. King Cable Safety Device, Quick Release Couplings, Manifolds, Air Valves, Blow Guns, Tube Fittings & Valves, Filters, Regulators, Thermometers, Gauges, Hose Racks & Reels, Safety Check Valves.

BRASS FITTINGS



Hose Stations, Nozzles, Garden Hose Fittings, Garden Hose, Brass Shank Fittings, Brass Fittings, Ferrules, Crimping Tools.

CAM & GROOVE



Full Range of Cam & Groove to MIL- C-27487, DIN 2828, "Andrews", "Boss-lock", "EZ Boss-lock" Brands, High Pressure Range up to 60 Bar, Stainless Steel, Aluminium, Brass, Bronze, Polypropylene, Reducing Couplers, Adapters, Gaskets, Spares, Accessories, Dry Disconnects, Crimp Style.

CLAMPS



Heavy Duty & Spiral, Single & Double Bolt Clamps, Worm Gear, Band Clamps, T-Bolt Clamps, Aero Seal. Air, Steam, Hygienic & Industrial Application Clamp Range, Clamp Kits, Tools & Accessories.

DIN STANDARD PRODUCTS



Storz Couplings, Smooth Tails & Safety Clamps - DIN 2817, Cam & Groove DIN 2828, Fixed & Swivel Flanges (DIN 2817, 2362 & 2673). Hygienic Din Fittings & Clamps, Tank Wagon Couplings (DIN 28450), Spares & Seals, Steam DIN 2826 Male, Female & Flanged Fittings & Couplings.

FITTINGS & ADAPTERS



Hydraulic Pipe Fittings, Weld End Pipe Fittings, Flanged Fittings, Flanges, Reducers, Threaded Adapters, Plugs, Caps, Swivel Adapters.

HYGIENIC VALVES & FITTINGS



Couplings (DIN, RJT, SMS, IDF, Tri-Clamp), Clamps, Gaskets, Elbows, Tees, Ferrules, Reducers, Valves (Butterfly, Ball & Check), Sight Glasses, Hose Assemblies, Wash Down Guns, Biopharm, Dairy, Actuated Valves, Bespoke Fabricated Configurations.

PERMANENTLY ATTACHED FITTINGS - HOLEDALL®



Plain End Stem, Threaded Stem, Victaulic Groove Stem, Flanged Stem, Ferrules, Hygienic, Industrial, Concrete Placement & Offshore Range, Rotary & High Pressure, Frac Fittings, Internal Swaging Machines & Accessories.

QUICK RELEASE FITTINGS



Range of Pneumatic, Hydraulic, Dry Disconnects. ISO-A & ISO-B Interchange, ISO 16028 Flushface, Snap-Tite, CEJN, Hansen, Bowes, Macdonald, Faster, Rectus, Stucchi, Tema Interchanges.

STEAM COUPLINGS & CLAMPS - 'BOSS'



"Boss" & "EZ-boss" Ground Joint & Washer Type Couplings, "Boss" Clamps, Stems & Adapters, Air Hammer Fittings, "Boss"/Holedall Fittings, Steam Quick Disconnects. DIN 2826 Male, Female & Flanged.

SWIVEL JOINTS



V-Ring Type & O-Ring Type Swivel Joints.

PETROLEUM, DRY BULK & OVERFILL PREVENTION



Adapters & Couplers, Valves, Caps, Gauge Hatches, FloTech™ Overfill Prevention, Nozzles, Pressure & Vacuum Valves, Reducers, Tank Truck Fittings, Shank Couplings, Pipe Caps, Sight Flow Indicators.

VALVES



Ball, Butterfly, Gate & Foot, Steel, Stainless Steel & Polypropylene, Strainers, Skimmers, Safety Check, Steam, Air, Hygienic & Actuated Valves.

WATER COUPLINGS



Agri Lock, Bauer Type, Hinge Lock, Victaulic, Geka Type, King Shank, King Combination Nipples, Wash Down Guns.

Spiral Hose Guard



Technical Characteristics	
Application	Provides heavy duty hose, cable or wire protection. Used in mining, quarrying, forestry, offshore industries and most hydraulic hose applications
Features	<ul style="list-style-type: none"> • Crush and high abrasion resistance • Chemical and UV ray resistant • Self-lubricating to reduce hose wear • Easy to install on-site • Smooth radius on all edges • Can be used on single or multiple hose bundles • Approved by MSHA 1C-231/1
Colour	Black, red, blue, yellow
Temperature Range	-50°C to 90°C, (-58°F to 194°F)

Hose Tags



Technical Characteristics	
Application	Dixon offers a comprehensive range of tags and labels that can be applied to a wide variety of hoses and related components. These tags are resistant to oil, grease and hydraulic fluids

All Hose Assemblies compliant with Pressure Equipment Directive 2014/68/EU

We reserve the right to change hose specifications without prior notice

Fire Jacket



Technical Characteristics	
Application	Used to protect hose and hose assemblies, tubing, piping, wiring and cables from high temperatures or molten splash. Will also help maintain line temperature and reduce environmental overheating and overcooling
Features	<ul style="list-style-type: none"> Resistant to hydraulic fluids and lubricating oil Supplied in 50ft lengths, (not continuous) Sleeving slides easily over hose and expands to go over fittings
Colour	Iron oxide red
Temperature Range	-54°C to 260°C, (-65°F to 500°F)
Materials	<ul style="list-style-type: none"> Compounded silicone rubber coating over fiberglass Completely non-asbestos

King Cable™ Hose Restraint

CORRECT

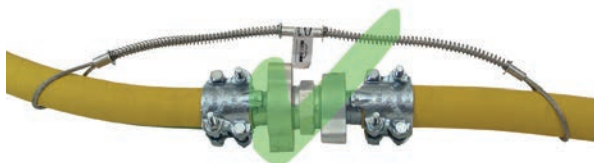

INCORRECT

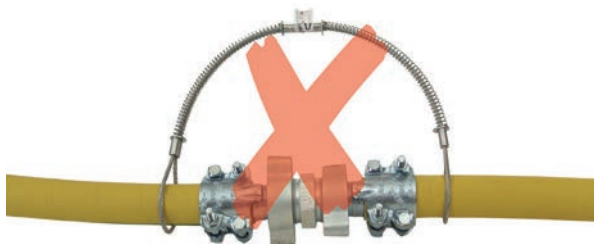

Technical Characteristics	
Application	Dixon King Cable Hose Restraints minimise damage to equipment and injuries to personnel. Reaches across the hose fittings to provide standby safety for hose
Features	<p>Spring-loaded loops in the cable ends open easily to pass over the couplings for a firm grip on the hose.</p> <ul style="list-style-type: none"> Hose-to-hose or hose-to-rigid outlet King cable is the low cost answer to eliminate injuries caused by broken air Hose connections Highly resistant to rust and corrosion No tools needed - easy to install and remove Maximum working pressure: 200 PSI
Material	<ul style="list-style-type: none"> Safety clip & lanyard used to lock Air King couplings Stainless steel safety marine eye used to connect safety cable to a bolt on tool Bronze/copper ferrule for special environmental conditions.e.g.mining/offshore

All Hose Assemblies compliant with Pressure Equipment Directive 2014/68/EU

We reserve the right to change hose specifications without prior notice

Nylon King Cable™



Technical Characteristics	
Application	Ideally suited for applications where the media being transferred is under higher working pressures such as air, water, hydraulic and slurry
Features	<ul style="list-style-type: none"> • Strong, flexible nylon webbing • Superior corrosion and spark resistance over metal restraints • Rubber grommets securely choke eyes around hose • Must be installed in the extended position (no slack) • Shipped with labels detailing working pressures and safety instructions • Maximum working temperature: 93°C • Minimises damage to equipment and injuries to operators in the event hose, couplings or clamps fail, or there is an accidental separation of the assembly
Materials	<ul style="list-style-type: none"> • Strap: nylon • Grommets: rubber

King™ Safety Whipsocks



Technical Characteristics	
Application	Pneumatic, hydraulic and water hoses
Features	<ul style="list-style-type: none"> • King™ Safety Whipsocks keep the hose under control in the event of a high-pressure hose assembly failure. • Dual anchor points secured beyond the fittings eliminate hose whip • Be sure the anchoring points are rated for the application • Galvanised steel woven stockings extend down the hose to grip securely over a larger area preventing whip, abrasion and wear • Securing both eye-to-rigid or eye-to-eye anchor points reduce whip in the event of a hose connection failure
Materials	<ul style="list-style-type: none"> • Wire rope: galvanised carbon steel • Ferrules: Aluminium

OTHER HOSE ACCESSORIES AVAILABLE ON REQUEST:

- HEAT SHRINK • BOUNCE RINGS • SCUFF STRIPS • SPRING GUARD • GRIPLOCK • FOAM PIPE INSULATION

All Hose Assemblies compliant with Pressure Equipment Directive 2014/68/EU

We reserve the right to change hose specifications without prior notice

S.T.A.M.P.E.D.

When fabricating and specifying hose assemblies ask the following questions:

<u>Size:</u>	What is the I.D. (Inside Diameter) of the hose? What is the O.D. (Outside Diameter) of both ends of the hose? What is the overall length of the assembly required?
<u>Temperature:</u>	What is the temperature range of the media (product) that is flowing through the hose assembly? What is the temperature range of the environment that surrounds the outside of the hose assembly?
<u>Application:</u>	How is the hose assembly actually being used? Is it a pressure application? Is it a vacuum (suction) application? Is it a gravity flow application? Are there any special requirements that the hose assembly is expected to perform? Is the hose being used in a horizontal or vertical position? Are there any pulsations or vibrations acting on the hose assembly?
<u>Media:</u>	What is the media/material that is flowing through the hose assembly? Being specific is critical. Check for: Abrasive materials, chemical compatibility, etc.
<u>Pressure:</u>	What is the maximum pressure including surges (or, maximum vacuum) that this hose assembly will be subjected to? Always rate the maximum working pressure of your hose assembly by the lowest rated component in the system.
<u>Ends:</u>	What couplings have been requested by the user? Are they the proper fittings for the application and hose selected?
<u>Dixon:</u>	Dixon recommends that, based on the hose, fittings and attachment method used, all assemblies be permanently marked with the designed working pressure and intended media. Do not use other manufacturer's fittings or ferrules with Dixon products due to the differences in dimensions and tolerances. We also recommend that all hose assemblies be tested frequently.

All Hose Assemblies compliant with Pressure Equipment Directive 2014/68/EU

We reserve the right to change hose specifications without prior notice



B.E.S.A.F.E.

We encourage you to share this information with anyone who may be effected by the selection, installation, maintenance or use of any hose assembly. Always use quality products to B.E.S.A.F.E.

Hose assemblies must be inspected prior to each use. Worn out fittings, attachment devices, hose and accessory items must be replaced. Retaining devices (safety devices) such as clips, cables or chains must be used. Clamps must be checked regularly to the specified torque found in the Dixon literature. Under no circumstance should any coupling be disconnected while under pressure unless the coupling is specifically designed to do so. Disconnecting couplings under pressure could result in serious injury or death, and destruction to property and equipment.

For all hose assemblies in use:

<u>Beware</u>	...hose assemblies when used improperly or in the wrong application can be dangerous. The maximum working pressure shown on the hose is not an indication of the working pressure of the assembly. Based on the hose, fittings and attachment method used all assemblies should be permanently marked with the designed working pressure and the intended media. The assembly working pressure should be permanently displayed. Hose assemblies must be used for the intended service only. Never alter manufactured product or substitute component parts.
<u>Eliminate</u>	...hazardous conditions by inspecting, maintaining and testing hose assemblies. Dixon recommends that all hose assemblies are tested in accordance with the hose manufacturer's specifications. The application determines the regularity of the re-testing schedule.
<u>Secure</u>	...and inspect hose, fittings, clamping devices and safety accessories before each use. Never take for granted that the coupling or attachment devices are properly installed.
<u>Always</u>	...inspect and re-tighten the bolts of any bolt style clamping device to the manufacturer's torque specifications.
<u>Fittings</u>	...hose and clamping devices that are worn out or damaged must be removed from service.
<u>Educate</u>	...your employees about the proper use, care and potential hazards of hose assemblies. Take advantage of Dixon's free Hose Assembly Safety Programme and the follow up Training Seminar to aid you in setting up your own inspection programme. Any questions on applications, use or assembly call our technical support team.

Hose and Hose Coupling Safety

“The very properties that make compressed gases useful in almost every area of modern life can also make them dangerous when mishandled. Years of experience with compressed gases have led to practices and equipment which, if employed, result in complete safety.”**

Dixon hose couplings have been carefully engineered to meet specific requirements. If hose or couplings are not used in correct applications or are incorrectly applied, accidents and downtime can result. It is up to the end user to inform the distributor of the application and pressures involved when ordering hose assemblies and it is up to the distributor to supply the right hose and coupling for that application. When in doubt, Dixon is here to help you with a proper coupling recommendation.

1. Air hose couplings

This form of energy can be one of the most dangerous because it is used in so many applications and, when mishandled, can have more serious results than fluids. Air, as a gas, is compressible (fluids press only against hose or vessel walls and lose little volume under pressure). When pressurised air releases suddenly, it does so with explosive force and can cause rapid hose whip, which can do serious physical harm to personnel or damage to nearby objects. This is why the selection of proper hose and couplings for air lines is so important, along with their proper installation and maintenance. Never take for granted that a coupling is installed properly or a clamp fully tightened on an air hose - check it regularly and use safety devices (see paragraph 4).

2. Steam and gas

The same rules apply for steam and gas, but, because these are inherently more hazardous materials, personnel tend to treat hose and couplings on these lines with more respect and care. Checking clamp tightness is very important with steam hose, where it is not unusual for clamps to loosen in service, in which case they must be retightened! Safety devices should also be used (see paragraph 4).

3. Fluid hose couplings

Again, nothing should be taken for granted - in particular, check clamps for tightness each time the lines are used - especially when petroleum products or other hazardous liquids are involved. Large diameter hose, when suspended, can also be quite dangerous if it drops unexpectedly due to a coupling “pull-out” or sudden disconnection. A heavy fitting or clamp, plus the weight of the hose itself falling from any significant height, can cause injuries or damage. Be sure to use safety devices (see paragraph 4).

4. All hose assemblies

All hose assemblies should be treated with respect as potential hazards. Worn-out fittings should be replaced. Retaining devices such as clips, cables or chains should be used. Clamps should be checked regularly. Under no circumstances should any coupling be disconnected while under pressure, unless the coupling is specifically designed to do so. Disconnecting couplings under pressure could result in serious injury or death, and destruction of property and equipment.

***Handbook of Compressed Gases”

General Safety Information

Pressure Ratings

Pressure ratings for couplings, as stated in this catalogue, are based upon ambient temperature (21°C or 70°F) applications with true hose I.D., new Dixon supplied couplings, new Dixon supplied clamps, new quality hose, and proper installation by a qualified assembler using Dixon procedures and equipment. In addition, temperature can affect coupling retention. For temperatures other than ambient (21°C or 70°F) contact the hose manufacturer or call Dixon.

Product Selection

Many of the products in this catalogue are used in hose assemblies in a variety of applications. The safety of any hose assembly rests on the proper selection, installation, testing and use of each product. The safe use of any product in this catalogue is dependent upon the correct selection of the hose, fittings and method of attachment. To ensure such a proper selection, the user must inform the distributor of the application and pressure involved when ordering hose assemblies. The use of S.T.A.M.P.E.D. (Size, Temperature, Application, Media, Pressure, Ends, Dixon) will help in the proper selection of hose assembly components (see next page). The selection of couplings and clamping devices is the responsibility of the purchaser or user, based upon the hose manufacturer's recommendations. If the purchaser or user is uncertain about the use or application of a product, Dixon stands ready to provide information, including test results (if available), coupling and clamping recommendations and other data to help resolve those matters.

Installation

To achieve a safe and reliable assembly, proper installation procedures must be followed. Each component of the assembly has a part in determining these procedures. The purchaser or user must follow proper procedures.

If the purchaser or user has any questions regarding installation, please contact Dixon.

Testing

Dixon recommends that all hose assemblies be tested in accordance with the hose manufacturer's recommendations.

Re-testing and inspection

Dixon recommends inspection and re-testing of hose assemblies on a regular and consistent basis in accordance with the hose manufacturer's recommendations. The application determines the regularity of the inspection and retesting schedule. Any worn-out fittings, damaged hoses or missing safety devices should be replaced immediately. Bolt-style clamps must be checked and retightened on a regular and consistent basis.

Proper selection, care, use and maintenance of hose couplings and accessory items

All hose assemblies should be viewed as potential hazards. This document is designed to inform and educate anyone who manufactures, specifies, supplies, purchases, assembles, uses, maintains or tests any hose assembly or its component parts. The proper selection and maintenance of hose, couplings, attachment devices and accessories are imperative. It is the end users responsibility to identify to the distributor the application and any special conditions that the hose assembly must meet. It is the distributors responsibility to supply the proper assembly for the intended application. Accidents and down time may occur if hose assemblies are not properly selected for the specific application. The performance and safety of the assembly is affected by the quality of the individual components. The use of the acronym S.T.A.M.P.E.D. (Size, Temperature, Application, Media, Pressure, Ends, Dixon) will help in the proper selection of the hose assembly components (see following page).

WARNING!

Failure to use these procedures can result in serious injury or death, and destruction of property and equipment.

Dixon Hose Assembling

To provide a complete service to its customers, Dixon has made considerable investment in its extensive in-house hose assembling capabilities, under pinned by a traceable Quality System in accordance with BSEN ISO 9001:2008 and compliance with PED 2014/68/EU. The capability is supported by a huge inventory of couplings to produce hose assemblies utilising the following methods:

Rubber, PTFE* and Composite**

- Internal Expansion (IX) 25mm to 305mm nominal bore
- External Crimp (EC) 6mm to 102mm nominal bore
- External Swage (ES) 25mm to 102mm nominal bore

* EC only, **EC & ES only

Rubber and PVC

- Heavy Duty Double Bolt Clamps
- Band & Pre-formed Band Clamps
- Heavy Duty T-Bolt Clamps
- Hi-Torque Clamps
- Compression Rings
- BSEN 14420-3:2004 Safety Clamps (formerly DIN 2817 etc)

Metal

- Welding procedures are in accordance with ASME IX, and BSEN 288
- Welders Qualifications to ASME IX and BSEN 287

Test procedures and additional services

Our pressure testing facilities include:

- Pneumatic Leak Test (Air under Water)
- Hydrostatic Proof and Burst tests up to 380 bar (5510 psig)
- Hydrostatic Proof and Burst test certification can be supplied with a Chart Recorder read-out if requested at time of order placement
- Assemblies can also be Hydrostatically tested using de-mineralised water (Maximum Chloride content of 30mg/l) when requested
- Liquid Penetrant Inspection to ASME V Article 6 & ASME B31.3 Table 341.3.2
- Liquid Penetrant Technicians qualified to PCN Level 2
- Sub-Contract X-Ray in accordance with ASME V Article 6 with acceptance level to ASME B31.3 Table 341.3.2
- Endoscope
- Chemical Etching
- Tagging

Pressure Equipment Directive 2014/68/EU

The Pressure Equipment Directive 2014/68/EU was embraced by the European Parliament and the Council of Ministers on 29 May 1997, enforced a further 2 years later on 29 November 1999 but with a 3 year grace, whereby compliance to its requirements were elective until 29 May 2002.

Failure to comply could result in prosecution by way of a fine, prison sentence or both.

On the whole the PED is legislation across the European Environment Agency (EEA), which requires that all pressure equipment must be fully compliant with regards to particular aspects such as material selection, design, manufacturing techniques, personnel qualification, testing requirements, product marking and user liability.

The Directive covers pressure equipment and assemblies with a maximum allowable pressure PS greater than 0.5 bar and includes such equipment as reaction vessels, industrial pipe-work, pressurised storage containers, heat exchangers, pressure accessories and safety devices. The PED's interpretation of an assembly being several pieces of pressure equipment assembled to form an integrated system.

PED accreditation, where applicable, allows for the active placing of the CE mark on pressure equipment and is a given passport to free trade within the EEA, without the need for statutory inspection by current Member States.

As a result, Dixon Group Europe have revised their manufacturing methodology and integrated an already efficient ISO 9001 quality management system with the Essential Safety Requirements of the PED, accredited by Lloyds Register, Notified Body Number 0038.

For further information on how this can benefit your business, please contact us on 01772 323529.

Metallic Hose Assembly Length Tolerances

Dimension Tolerances meeting the requirements of class 1 of the EN ISO 10380 standard applies to all Dixon metallic hose assemblies.

- Lengths above 1m shall be manufactured to +3% & -1% tolerance
- Lengths below 1m shall to manufactured + 1 & -1% corrugation

These tolerances are applicable regardless of bore size. Lengths below 1m is Dixon's definition of a short length.

De-rating factors will apply for elevated temperature applications, refer to the technical section or call Dixon for further information.

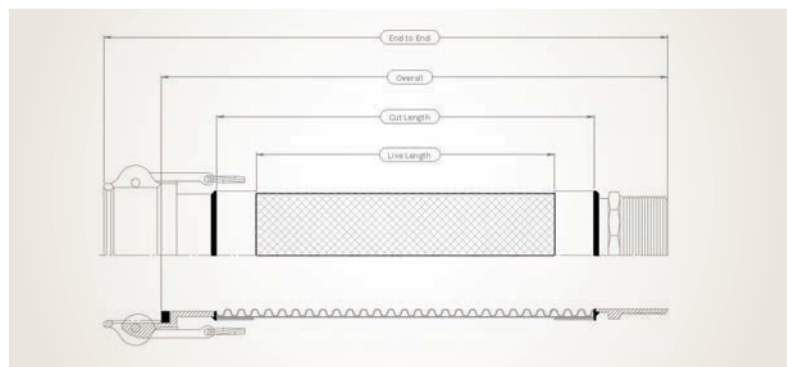
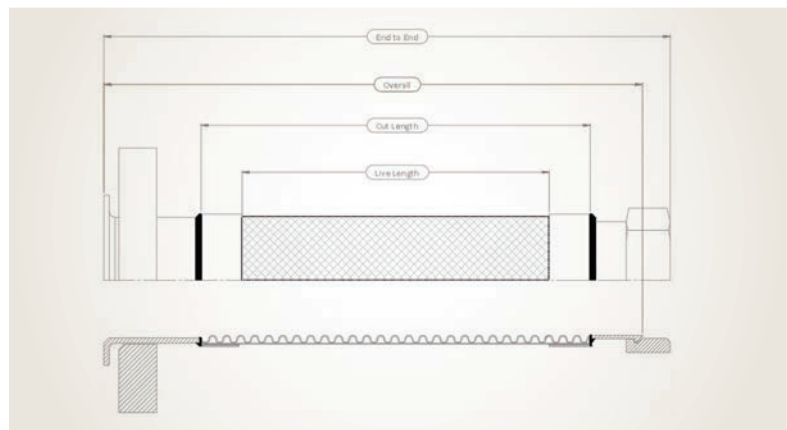

Procedure For Sanitising Dixon Food Hoses

The sanitising procedure incorporates all those physical and chemical treatments which are essential to guarantee that the tube can be labelled “clean” from physical, chemical and biological aspects.

A surface can be considered clean when there is no trace of contaminants and is not unctuous to the touch.

Please follow the instructions mentioned below to ensure that no noxious substances or processing residues may affect the conveyed foodstuffs.

FIRST CLEANING

Normally new hoses have the typical “rubber smell” and may contain different processing residues such as surfactants and dust. These hoses should be treated before their use with hot water (80-90°C), phosphoric acid (max. 2% for 10 minutes), followed by a sodium hydroxide solution (max. 5% for 15 minutes) and finally rinsed with potable water. The possible drying can be done with steam at 110°C (max. for 30 minutes).

SANITISING

Our food-quality hoses may be treated with the most common cleaning agents and disinfectants, including the Clean-in-Place (CIP) procedures. We suggest in any case to follow the concentrations and the instructions given by the Manufacturers of the detergents in question.

In order to guarantee the optimal life of the hoses we recommend to follow the following indications:

TUBE	NR	NBR	EPDM	IIR	UHMWPE
Steam	110°C max. 30 min.	110°C max. 30 min.	110°C max. 30 min.	110°C max. 30 min.	110°C max. 30 min.
Soda	5% x 15 min.	5% x 15 min.	5% x 15 min.	5% x 15 min.	5% x 15 min.
Peracetic Acid	1% x 30 min	1% x 30 min	1% x 30 min	1% x 30 min	1% x 30 min
Phosphoric Acid	2% x 10 min.	2% x 10 min.	2% x 15 min.	2% x 15 min.	2% x 15 min.
Nitric Acid	2% x 10 min.	2% x 10 min.	2% x 15 min.	2% x 15 min.	2% x 15 min.

The cleaning and sanitising procedure of the food-quality hoses, if carried out at normal conditions, neither causes changes in their properties nor affects their life-time.

On the contrary, the treatment at extreme temperatures and concentrations, or for too long time, will quickly weaken the materials properties and consequently will considerably shorten the life of the hose.

Installation & Safety: Metallic Hose

When installed correctly within the design parameters of the hose to be used, Stainless Steel hose assemblies can give many years of satisfactory life. To help maximise the working life the following rules should be observed.

Torque - Stainless Steel hose assemblies should never be subject to torque.

Hose is subjected to torque by:

1. Twisting during installation. This can be minimised by the use of a swivel joint at one end, where the fixed fitting is tightened up first. Two spanners should be used on union fittings.
2. Twisting when flexed. The hose should be installed so that flexing takes place in one plane only and the direction of motion must be perpendicular to the centre line of the hose. Pipework must be anchored and guided at each change of direction where a hose is used to absorb pipework movement.

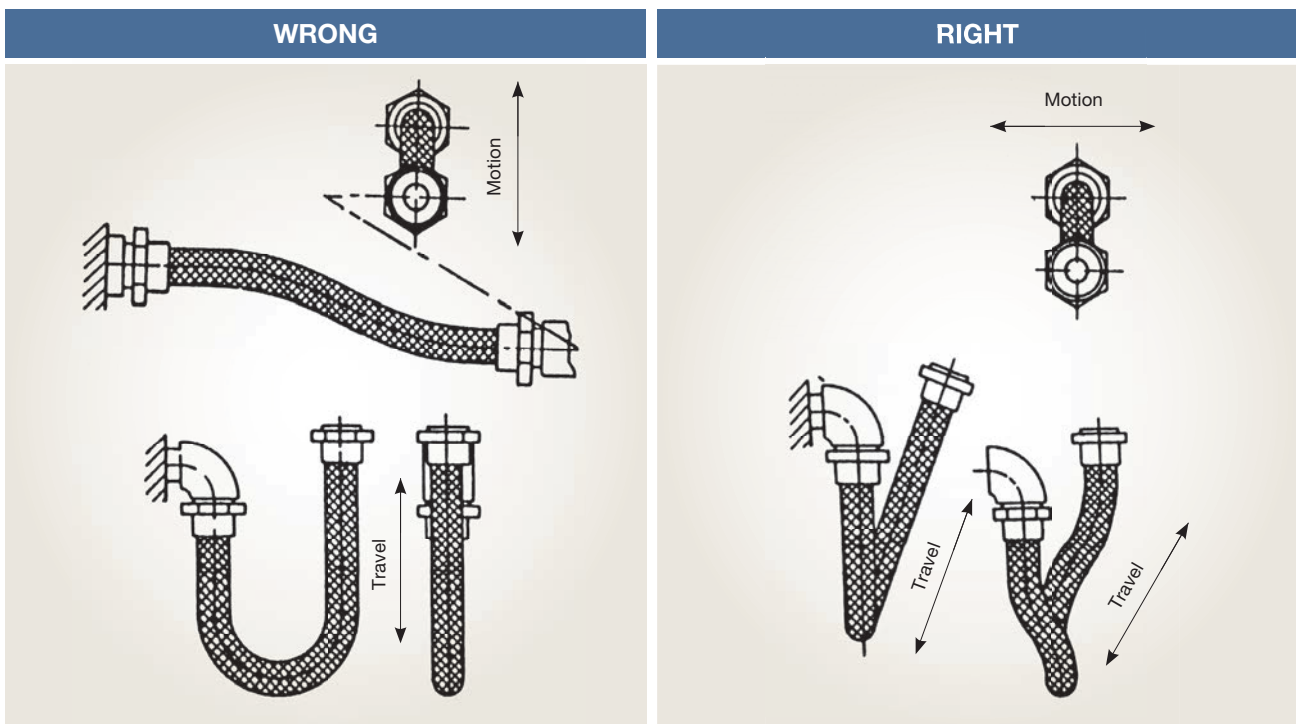

Rubbing - Any signs of external damage should cause the hose to be replaced. Damage to the braid will cause the pressure capacity of the hose to be compromised, possibly endangering personnel.

Pressure - Always refer to the maximum working pressure of the hose before installation. Always take into account the other working conditions such as temperature and pulsation.

Pulsation or Shock Pressures - These can be caused by the fast opening or closing of valves etc. and can cause premature failure through metal fatigue. Where this cannot be avoided the maximum working pressure of the hose should be reduced by 50%. Installation should be in a straight line with no slack on the braid.

Small Radii - Small radii should be avoided and the minimum centre line bend radius of the hose should always be observed. Be aware of the different bend radii for dynamic (i.e. constantly moving) and static (i.e. anti vibration) applications. The use of Parrap hose or solid elbows should be considered. If the application causes the hose to flex below the minimum bend radius near the ferrule, the use of a hose 'bend limiter' can be considered.

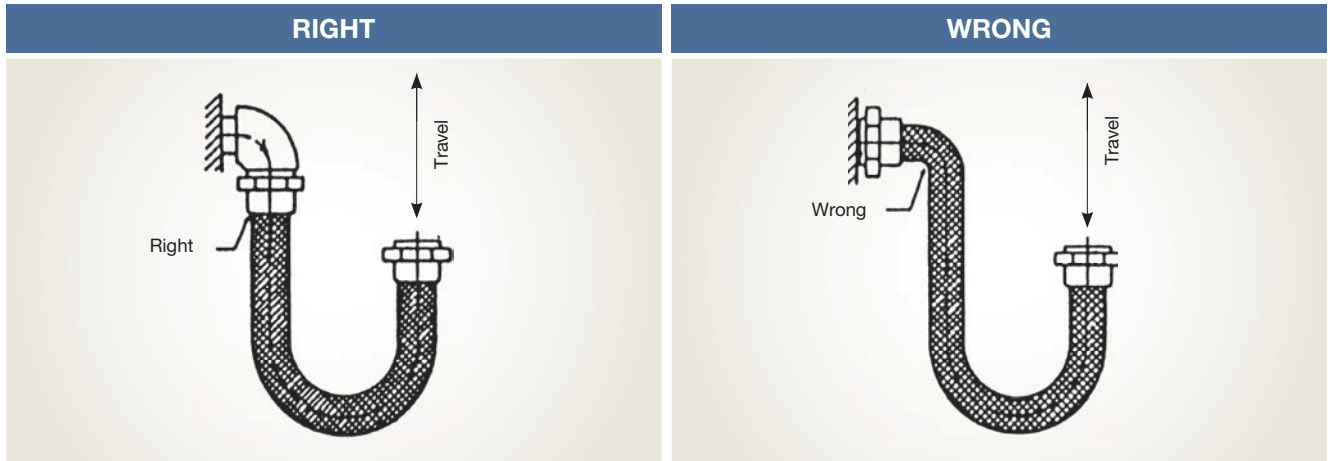

Flow Velocity - The convolutions can effect high flow velocities in one of two ways:

1. Turbulence. Velocities above 150 Ft/Sec for Gas or 75 Ft/Sec for Liquid can cause turbulence within the hose convolutions leading to metal fatigue. To overcome this, the use of the next size of hose, with or without a liner, can be effective. For hoses bent through 90° the above flows should be reduced by 50%, for 45° reduce by 25%.
2. Pressure Loss. As a rough guide it can be assumed that the pressure loss in a Convulated Stainless Steel hose is twice that for new, welded steel pipe. This means that an increase in the bore size of 15% will reduce the pressure loss to that of the steel pipe.

Temperature:

When operating at elevated temperatures, a 'correction' factor should be applied to reflect the changed state of the hose material.

STAINLESS STEEL CORE GRADE 321 (1.4541)										
TEMPERATURE °C	-200	-150	-100	-50	0	50	100	150	200	250
FACTOR	1	1	1	1	1	0.93	0.83	0.78	0.74	0.70
TEMPERATURE °C	300	350	400	450	500	550	600	650		
FACTOR	0.66	0.64	0.62	0.60	0.59	0.58	Enquire	Enquire		

STAINLESS STEEL CORE GRADE 316 (1.4404)										
TEMPERATURE °C	-200	-150	-100	-50	0	50	100	150	200	250
FACTOR	1	1	1	1	1	0.90	0.73	0.67	0.61	0.58
TEMPERATURE °C	300	350	400	450	500	550	600	650		
FACTOR	0.53	0.51	0.50	0.49	0.47	0.47	Enquire	Enquire		

The above information is intended as a guide only, and as such the above specifications cannot be held to be mandatory. Dixon reserves the right to change and modify designs and specification without notice.

Dixon Flexible Hose Assembly Installation, Maintenance & Safety Guidelines

Provided the correct and full conditions of use have been given at the time of order placement and the assembly is subsequently installed within its design parameters, the flexible hose assembly (FHA) or pressure equipment can give many years of satisfactory service life. To help maximise this service life the following guidelines should be followed.

1. Integrity

The integrity of FHAs is very dependant on the correct selection of hose product and adherence to the installation procedures. Dixon suggest that all personnel required to install, inspect and maintain FHAs should be formally authorised, and fully conversant with the appropriate installation, test and maintenance procedures, failure criteria etc.

2. Safety Considerations

- FHAs should not be used where it is safer to install permanent pipework.
- Design – FHA's suitability with systems piping and equipment.
- Application – suitability of the FHA in relation to media, pressures, temperature and when used in suction applications, ability to withstand vacuum.
- External Environment - FHAs should only be used for duties for which they are approved.
- Installation - FHA's should be adequately supported and installed to the manufacturer guidelines, as applicable and consistent with the best practice principles contained within this guidance document.
- Length – FHA's should be kept to a minimum, consistent with flexibility and required function.
- Electricity – dangers of static electricity in the application and effects on all components associated with FHA's continuity requirements.

3. Vibration/Movement

FHAs may eliminate the transmission of vibration or movement in a specific application. FHAs will only efficiently eliminate the transmission of vibration, movement or noise if the adjacent pipework is properly anchored on the downstream side of the hose. In the worst cases, failure to ensure this can lead to uncontrolled movement of the FHAs and premature failure.

4. Misalignment

FHAs should not be used as a remedy for poor design or installation, eg to correct misalignment of rigid components.

5. Degradation

Degradation of FHAs can be accelerated due to heat, environmental conditions or contamination of the outer coverings and braids due to chemicals, ultraviolet light, ozone, salt, water etc. It should be noted that the fluid composition could change over the expected lifecycle.

Note: Heat tracing and insulation can considerably accelerate any corrosion mechanisms.

6. Storage

All FHAs should be stored in clean, dry conditions and hoses of rubber and composite construction should be kept in a cool atmosphere protected from direct sunlight. Some hose linings, if not protected prior to putting into service, have a finite shelf-life.

7. Cleaning and Flushing

All components used in a system that includes a FHA should be cleaned and flushed prior to use, to prevent debris being carried, damaging the liner of the hose.

8. Operations, Maintenance, Inspection & Testing

Users should ensure that all FHAs are subject to a periodic inspection routine. Only authorised, competent personnel should be permitted to install, inspect and maintain flexible hose lines. Visual inspection of the hose body for cuts, kinks, bulges, signs of abrasion, corrosion products etc. Particular attention should be focused close to the end coupling for signs of over-bending or leakage.

9. Changing Conditions

The user should be aware of changing conditions, which may move the FHAs away from the original design intent. Changes can include, but are not limited to: pressure, temperature, flow, media etc.

10. User's/Purchaser's Responsibility to Define Requirements

The user or purchaser of any FHA should always ensure that the following information is provided as applicable:

Always consider and properly define the application of the FHA by referring to:

STAMPED: Size, Temperature, Application, Media, Pressure, Ends, Dixon. In addition consider static or dynamic use of hose and the working environment.

11. Legal Requirements

It is a legal requirement under health and safety law, power regulations and the Pressure Equipment Directive 2014/68/EU that those responsible for work activities ensure that hazards are adequately identified risks are adequately assessed and that suitable control measures are put into place.



Installation

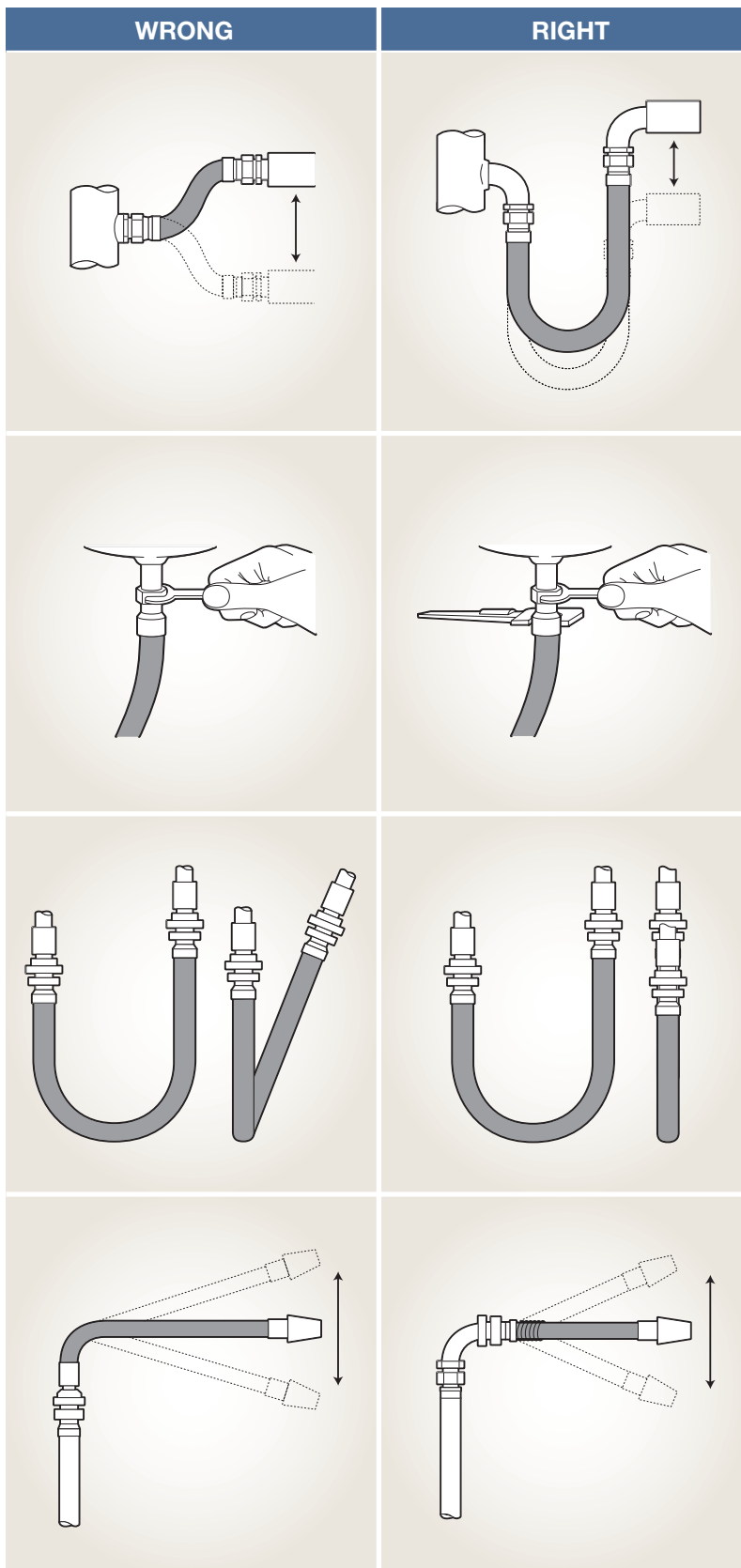

Flexible Hose Assemblies (FHA's) should always be handled with reasonable care, and should not be subjected to over straining. The design of hose supports and saddles should be to ensure that the minimum bend radius is not compromised.

FHAs should never be forcefully deformed, crushed, twisted or subject to flow shut-off by kinking.

Avoid routing or dragging FHAs over sharp or abrasive surfaces.

FHAs should not be allowed to hang between equipment that can move and cause FHAs to become over-stretched or bent.

The following considerations should be taken into account before the FHA is installed in either a static or flexing application:

- It is essential that the mating couplings are completely free from foreign matter, burrs etc. Damage, corrosion or contamination to the mating surfaces will cause joint failure in service.
- The installed bend radius of the FHA must not be less than the minimum bend radius specified.
- Union Nuts should be hand tightened at both ends and the FHA be allowed to adopt its natural position prior to tightening.
- FHAs should not be installed in a twisted condition, since this puts unbalanced tension on the hose and reduces the working life of the assembly.
- FHAs should not be installed in applications where compression, axial extension, or torsion could occur.
- Dixon always recommends the use of a 'King' Hose Safety Restraint Cable on FHA's.

Note: Poor installation can cause leaks and contamination

Taking Flexible Hose Assemblies Out Of Service

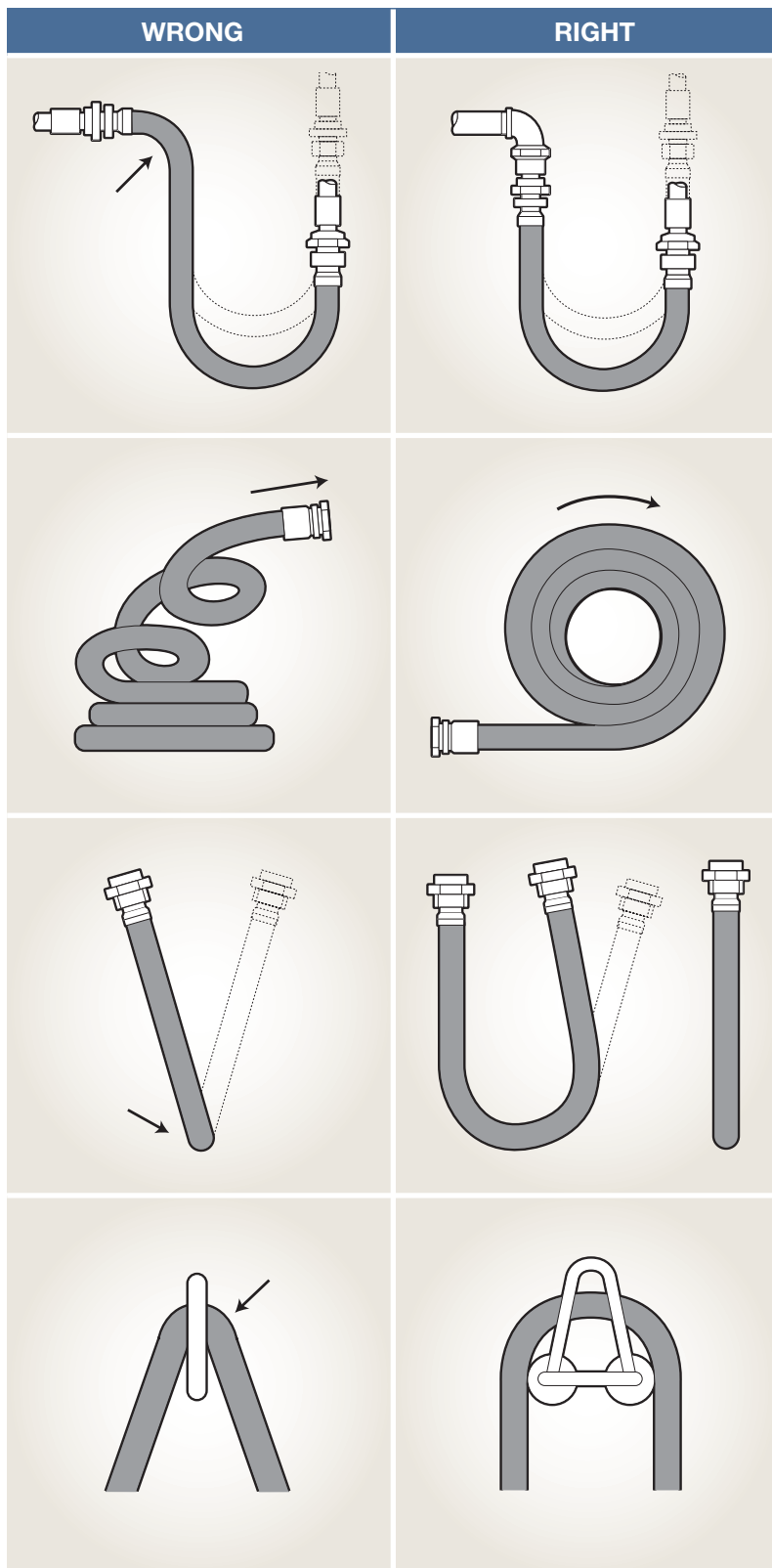

FHA's which have been taken out of service for a temporary period to be subsequently re-used at another time, should always have the media drained from the hose. The FHA should also be cleaned and flushed if required.

The FHA should then be stored in clean, dry conditions. FHA's of rubber and composite construction should be kept in a cool atmosphere protected from direct sunlight.

FHA's which have been identified as being unfit for purpose should have the end couplings removed, and the main carcass of the hose marked as 'Scrap'. It should then be disposed of in line with regional disposal segregation procedures, taking into account decontamination requirements.

For additional advice regarding installation, maintenance and the safe operational use of Flexible Hose Assemblies, please contact a member of the Dixon Sales Team.

BE SAFE - ALWAYS SPECIFY DIXON PRODUCT

Note: Poor installation reduces hose life and can be potentially hazardous

Hose & Coupling Site Safety Survey

At Dixon we recognise the need for onsite safety and how understanding the importance this holds and helps generate a stronger relationship with your customer.

As a result Dixon now offers hose and coupling safety surveys.

Today, plant safety is an ongoing endeavour where it is impossible to be an expert in every field. The use of damaged or misapplied hose couplings and related items occurs. To the untrained eye these hazards may continue to exist until an accident happens threatening not only plant machinery but also the well being of personnel.

Dixon can assist in your efforts to make the facilities you service as safe, efficient and productive as possible.



Onsite Hose Testing & Management

Dixon offer a hose management programme designed to help make your facilities as safe, efficient and productive as possible.

The hose management program includes the regular test and inspection of onsite hoses along with a web based documentation and management tool.

Dixon-Hose Connect is a secure, user friendly web based app. It is a source to allow you to access your Hose Maintenance documentation, including Service History reports and Hose Asset Register via unique tag references and hose identifiers, as well as training videos for your site.

OUR PROGRAM INCLUDES:

- A visual inspection of hose assemblies and related accessories
- A professionally written report detailing our observations and recommendations for corrective action.
- The safety survey report is completely confidential and will only be shown to authorised parties.

Don't Forget:

Hoses from Dixon are Certified to PED 2014/68/EU Module D1 by Lloyds Register Quality Assurance.

When it's got to be right, it's got to be Dixon

For more information contact Dixon today on 01772 323529 or sales@dixoneurope.co.uk



Dixon Terms & Conditions

Limited Warranty

Dixon Group Europe Ltd (herein called "Dixon") warrants the products described herein, and manufactured by Dixon to be free from defects in material and workmanship for a period of one (1) year from date of shipment by Dixon under normal use and service. It's sole obligation under this warranty being limited to repairing or replacing, as hereinafter provided, at its option any product found to Dixon's satisfaction to be defective upon examination by it, provided that such product shall be returned for inspection to Dixon's factory within three (3) months after discovery of the defect. The repair or replacement of defective products will be made without charge for parts or labour. This warranty shall not apply to: (a) parts or products not manufactured by Dixon, the warranty of such items being limited to the actual warranty extended to Dixon by its supplier; (b) any product that has been subject to abuse, negligence, accident, or misapplication; (c) any product altered or repaired by others than Dixon; and (d) to normal maintenance services and the replacement of service items (such as washers, gaskets and lubricants) made in connection with such services. To the extent permitted by United Kingdom law, this limited warranty shall extend only to the buyer and any other person reasonably expected to use or consume the goods who is injured in person by any breach of the warranty. No action may be brought against Dixon for an alleged breach of warranty unless such action is instituted within one (1) year from the date the cause of action accrues. This limited warranty shall be construed and enforced to the fullest extent allowable by applicable United Kingdom law.

OTHER THAN THE OBLIGATION OF DIXON SET FORTH HEREIN, DIXON DISCLAIMS ALL WARRANTIES, EXPRESS OR IMPLIED, INCLUDING BUT NOT LIMITED TO ANY IMPLIED WARRANTIES OF MERCHANTABILITY OR FITNESS FOR A PARTICULAR PURPOSE, AND ANY OTHER OBLIGATION OR LIABILITY. THE FOREGOING CONSTITUTES DIXON'S SOLE OBLIGATION WITH RESPECT TO DAMAGES, WHETHER DIRECT, INCIDENTAL OR CONSEQUENTIAL, RESULTING FROM THE USE OR PERFORMANCE OF THE PRODUCT.

Some products and sizes may be discontinued when stock is depleted, or may require a minimum quantity for ordering.

Dixon Group Europe Ltd is committed to a policy of continuous development, and as such, the above detailed specification and may be subject to change without notice. Dixon Group Europe Ltd reserves the right to change and modify designs and specification without notice.

Pricing

Dixon will always try to maintain pricing, however, with the fluctuation of material cost we may be forced to change prices. Please be aware pricing is subject to change without notice.

Freight/Postage & Carriage Charges

Postage & carriage charges are at the customer's expense and will be charged at current appropriate rates.

Returns

Dixon will allow its customers to return any product for any reason within 30 days of shipment, provided it is received in a saleable condition. The customer must call to receive a CCR number prior to returning goods to Dixon and shipping will be at the customer's expense, unless it is determined Dixon created the reason for the return.

A re-stocking charge of 25% applies to all returns.

Limits of Liability

This catalogue is intended as a product offering. It is not intended to be a user or technical manual. Information in this catalogue is subject to change without notice. All users and distributors of products sold through this catalogue should contact Dixon with questions of use, compatibility, coupling procedures and life of product. Dixon's full time engineering and test staff is always available to recommend uses and to assist distributors and users with questions.

Copyright

Copyright© 2018 by Dixon Group Europe Ltd.

All rights reserved. This book is copyrighted material. Use, reproduction or copying of it by anyone other than Dixon is strictly forbidden without its express written consent.



Dixon Europe

Dixon Deutschland GmbH

Godesberger Strasse 20b
D-53842 Troisdorf-Spich
Germany
Tel: +49 (0)2241 844 06-0
Email: info@dixon-deutschland.de

Dixon France

Parc Des Mardelles
44, rue Maurice de Broglie - Bât A15
93600 Aulnay-Sous-Bois
France
Tel: +33 171 84 10 16
Email: sales@dixonfrance.fr

Dixon Middle East

C3-035, PO Box 121599,
Saif Zone-Sharjah,
United Arab Emirates
Tel: +97165741488
Email: sales@dixonme.com

Dixon Russia

17A Aleksandrovskey Fermi Prospekt
192174
Saint Petersburg
Russia
Tel: +7 (812) 677 54 47
Email: info@dixonrussia.ru

Dixon Worldwide

Dixon Valve & Coupling Co

800 High Street
Chestertown
MD 21620
USA
Tel: +1 410 778 2000
Email: sales@dixonvalve.com

Dixon Shanghai

Room 801-803
No.3553 North Zhongshan Rd
Putuo District
Shanghai, China
Tel: +86 21 6173 7998
Email: enquiries@dixonvalve.com.cn

Dixon Asia Pacific



PO Box 2491
Regency Park
SA 5942
Australia
Tel: +61 8 8202 6000
Email: enquiries@dixonvalve.com.au

Dixon India

90, Virwani Industrial Estate,
Western Express Highway,
Goregaon East,
Mumbai – 400 063, India
Tel: +91-22-61949494 / 29271152
Email: salesindia@dixonvalve.com.au

Dixon Group Europe Limited

Dixon House, 350 Leach Place,
Walton Summit Centre, Preston PR5 8AS, UK.
Telephone: +44 (0)1772 323529
Fax: +44 (0)1772 314664
Email: sales@dixoneurope.co.uk
www.dixoneurope.co.uk / www.dixoneurope.eu

Stay connected with Dixon on  or 
www.youtube.com/user/DixonValve



Customer Service: **+44 (0)1772 323529**
Email: **sales@dixoneurope.co.uk**